

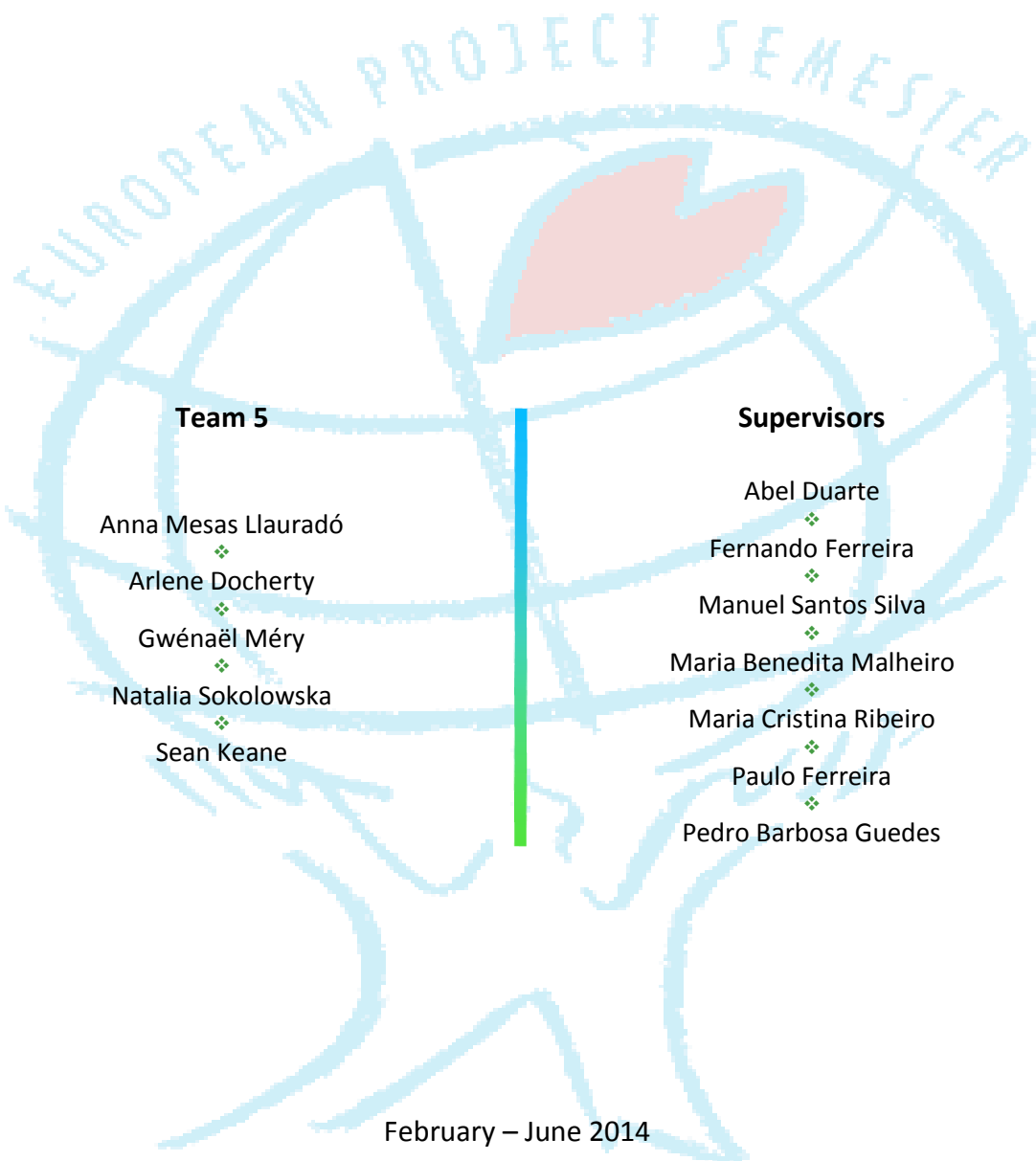

# Aquaponics System



Final report



## Team 5

Anna Mesas Llauradó  
◆  
Arlene Docherty  
◆  
Gwénaél Méry  
◆  
Natalia Sokolowska  
◆  
Sean Keane

## Supervisors

Abel Duarte  
◆  
Fernando Ferreira  
◆  
Manuel Santos Silva  
◆  
Maria Benedita Malheiro  
◆  
Maria Cristina Ribeiro  
◆  
Paulo Ferreira  
◆  
Pedro Barbosa Guedes

February – June 2014

# Abstract

---

Over recent years the research and development for aquaponics has received increased attention due to its possibilities in helping reduce strain on resources within 1st and 3rd world countries. Aquaponics is the combination of hydroponics and aquaculture and mimics a natural environment in order to successfully apply and enhance the understanding of natural cycles within an indoor process. By using this knowledge of natural cycles it is possible to create a system with the capabilities similar to that of a natural environment with the benefits of electronic adaptations to enhance the overall efficiency of the system. This paper covers our solution to this opportunity involving overall design, the technology involved and what benefits it could bring to the current market.

# Report structure

---

The report is structured into eight major chapters and a couple minor sections:

**Chapter 1 – Introduction:**

Present Team, project, objectives, motivations, problems and results we hope to achieve.

**Chapter 2 – State of the art:**

Describe Aquaponics' generalities and compare current systems already existing.

**Chapter 3 – Project management:**

How to manage a project effectively.

**Chapter 4 – Marketing plan:**

Use market analysis to find target market and product placement.

**Chapter 5 – Eco-efficiency measures for sustainability:**

Consideration of social, environmental and economic impact of system.

**Chapter 6 – Ethical and deontological concerns:**

Reflection of different codes of ethics upon our product and the market.

**Chapter 7 – Project development:**

Description of design and development of system as a functional product/prototype.

**Chapter 8 – Conclusions:**

Summary of report as a whole.

**The minor sections include:**

The acknowledgement, the glossary, the references, an index and appendices.

# Table of contents

<b>ABSTRACT</b>	<b>2</b>
<b>REPORT STRUCTURE</b>	<b>3</b>
<b>TABLE OF CONTENTS</b>	<b>4</b>
<b>CHAPTER 1</b>	<b>6</b>
<b>1. INTRODUCTION</b>	<b>6</b>
1.1. PRESENTATION	6
1.2. MOTIVATION	6
1.3. PROBLEM	6
1.4. OBJECTIVES	7
1.5. REQUIREMENTS	7
1.6. FUNCTIONAL TESTS	7
1.7. PROJECT PLANNING	8
<b>CHAPTER 2</b>	<b>9</b>
<b>2. STATE OF THE ART</b>	<b>9</b>
2.1. INTRODUCTION	9
2.2. FUNCTIONING	9
2.3. COMPONENTS	12
2.4. DIFFERENT TYPE OF CULTURE SYSTEM	14
2.5. WHAT PLANTS CAN BE USED?	19
2.6. FISH WITHIN AQUAPONIC SYSTEMS	20
2.7. STARTING THE AQUAPONICS SYSTEM	21
2.8. CYCLING THE SYSTEM	22
2.9. CONCLUSION	22
<b>CHAPTER 3</b>	<b>24</b>
<b>3. PROJECT MANAGEMENT</b>	<b>24</b>
3.1. SCOPE	24
3.2. TIME	25
3.3. COST	25
3.4. QUALITY	26
3.5. PEOPLE	26
3.6. COMMUNICATIONS	26
3.7. RISK	27
3.8. PROCUREMENT	27
3.9. STAKEHOLDERS MANAGEMENT	28
3.10. CONCLUSION	28
<b>CHAPTER 4</b>	<b>29</b>
<b>4. MARKETING PLAN</b>	<b>29</b>
4.1. INTRODUCTION	29
4.2. MARKET ANALYSIS	29
4.3. SWOT ANALYSIS (TABLE 6)	34



4.4. STRATEGIC OBJECTIVES	35
4.5. SEGMENTATION	35
4.6. STRATEGY/POSITIONING	36
4.7. ADAPTED MARKETING-MIX	39
4.8. BUDGET	42
4.9. STRATEGY CONTROL	43
4.10. CONCLUSION	43
<b>CHAPTER 5</b>	<b>44</b>
<b>5. ECO-EFFICIENCY MEASURES FOR SUSTAINABILITY</b>	<b>44</b>
5.1. INTRODUCTION	44
5.2. ENVIRONMENTAL	45
5.3. ECONOMICAL	45
5.4. SOCIAL	46
5.5. LIFE CYCLE ANALYSIS	46
5.6. CONCLUSION	47
<b>CHAPTER 6</b>	<b>48</b>
<b>6. ETHICAL AND DEONTOLOGICAL CONCERNS</b>	<b>48</b>
6.1. INTRODUCTION	48
6.2. ENGINEERING ETHICS <sup>[18]</sup>	48
6.3. SALES AND MARKETING ETHICS	52
6.4. ACADEMIC ETHICS	53
6.5. ENVIRONMENTAL ETHICS	54
6.6. LIABILITY	54
6.7. CONCLUSION	55
<b>CHAPTER 7</b>	<b>56</b>
<b>7. PROJECT DEVELOPMENT</b>	<b>56</b>
7.1. INTRODUCTION	56
7.2. ARCHITECTURE	56
7.3. COMPONENTS	63
7.4. FUNCTIONALITIES	70
7.5. TESTS AND RESULTS	71
7.6. CONCLUSION	73
<b>CHAPTER 8</b>	<b>74</b>
<b>8. CONCLUSIONS</b>	<b>74</b>
8.1. DISCUSSION	74
8.2. FUTURE DEVELOPMENT	74
<b>REFERENCES</b>	<b>75</b>
<b>LIST OF TABLES</b>	<b>79</b>
<b>LIST OF FIGURES</b>	<b>80</b>
<b>GLOSSARY</b>	<b>82</b>
<b>INDEX</b>	<b>84</b>



# Chapter 1

## 1. Introduction

### 1.1. Presentation

We are a group of 5 international students (Table 1). At the end of February 2014 we started a program called the European Project Semester at the Instituto Superior de Engenharia do Porto. During the semester we will work on a project lasting whole semester and we will participate in the complimentary classes.

Table 1: Team members



### 1.2. Motivation

As a group we came to an early decision that we would like to choose a proposal that incorporated sustainable techniques and been eco-friendly, as this is the future of all design/engineering. As a group we were all interested in creating our own aquaponics system as this is a system/technique that is becoming ever more popular throughout the world, more so in poorer regions and where water is a limited resource.

### 1.3. Problem

We were tasked with designing and building an aquaponics system that supports both fish and plant culture without the use of soil and supported by water recirculation. The system must be as sustainable as possible. From this, our idea's focussed on the sustainability of the system. We decided to target the household market as a small system



would be easier to control and keep sustainable compared to a large (small farm) sized system. This system would also allow us to create an aesthetic product that would sit within the home. Even though there are many aquaponics systems in use at a large scale there are not many for use within the home and this is why our market was targeted towards this area.

#### 1.4. Objectives

The main objective of the project is to create a working system as to support both fish and plant culture. The system must be able to be monitored so that optimum conditions are in place. This would mean using sensors to check temperature and other parameters. In order to fulfill the secondary objective of being as sustainable as possible we must look to use as little power as possible and be efficient when using the water recirculating so more water does not need to be inputted into the system. To use materials that have been recycled or reused as to be sustainable in creating the prototype.

#### 1.5. Requirements

There are a number of requirements needed to be fulfilled for the aquaponics project to work correctly. First of all it needs to be as much sustainable as it is possible. To achieve this we need to pay attention to the structure of the system: the water must recirculate and the amount of energy input to the system should be kept to a minimum. Secondly, our prototype must be easy to control. Therefore users of our Aquaponics system must be able to monitor parameters such as temperature, flow, conductivity, pH or dissolved oxygen. Moreover, due to the target we have chosen, which is the domestic use of our prototype, it requires having an attractive design. Furthermore, the project obligation is to reuse provided components or low cost hardware solution which we must take into account when constructing our system. Also it is necessary to use open source and free software and technologies.

#### 1.6. Functional tests

Following Tests must be completed by the end prototype in order to be considered functional:

- The water must be pumped from the tank to the grow bed at a set time according to the arduino.
- The water must then slowly drain from the grow bed over a set period of time.
- The fail-safe pipe must remove all water in case of a pump malfunction.
- Sensors must relay information to the user at all times through the screen.
- Both plant and fish culture must live together safely in a symbiotic environment.



### 1.7. Project planning

The work plan and the Gantt Chart were created. We divided the whole project into smaller parts and created the list of the tasks we need to complete. Afterwards, we allocated each task to the team members according to their skills and knowledge (Table 2). Next, in the Gantt Chart we specified details of each task and dates to perform it.

Table 2: Task attribution

Task	Responsible
The project and background information	All
Search components and materials	All
Marketing plan	Natalia
Development of the acquaponics system (plants, fish...)	All
Design	Sean
Interim report	All
Communication	Arlene and Sean
Ecological footprint and sustainability	Gwen and Sean
Ethical and deontological concerns	Anna
Project Development	All
Final report	All
Final presentation	All
Video, paper and poster	All
User manual and leaflet	All



# Chapter 2

---

## 2. State of the art

### 2.1. Introduction

Aquaponics is based on productive systems that can be found in nature. It can be described as the combination of aquaculture and hydroponics and this is where the name comes from: Aqua-ponics. [1]

Hydroponic systems rely on the use of nutrients made by humans for optimum growth of plants. Nutrients are manufactured from a blend of chemicals, mineral salts and trace elements to form the 'perfect' balance. Water in hydroponic systems must be discharged periodically, so that the salts and chemicals do not accumulate in the water which could become very toxic to plants.

Aquaponics combines the two systems in a symbiotic environment. It cancels the negative aspects of each. Instead of adding toxic chemical solutions to cultivate plants, Aquaponics uses highly nutrient effluent from fish that contain virtually all the nutrients needed for optimum growth of plants. Instead of discharging water, Aquaponics uses plants to cleanse and purify the water, after which the water is put back in the aquarium. This water can be re-used but must be topped up at certain stages due to losses from evaporation and plant usage. [2]

### 2.2. Functioning

#### 2.2.1. The nitrogen cycle

Invisible but essential to an aquaponics system is the benefit of bacteria. Bacteria thrive in the dark gravels of culture beds and breeze elements in the water in a form that plants can absorb and use. An aquaponics system is organic by nature. Synthetic fertilizers may not be given in food plants without risk of harm to fish and beneficial bacteria, the system must be maintained naturally. There are two different bacteria that break down fish waste, the first is the nitrosomonas, that convert ammonia to nitrite. These nitrites are then converted to nitrate by nitrobacter bacteria, plants can then consume nitrates and grow (Figure 1).



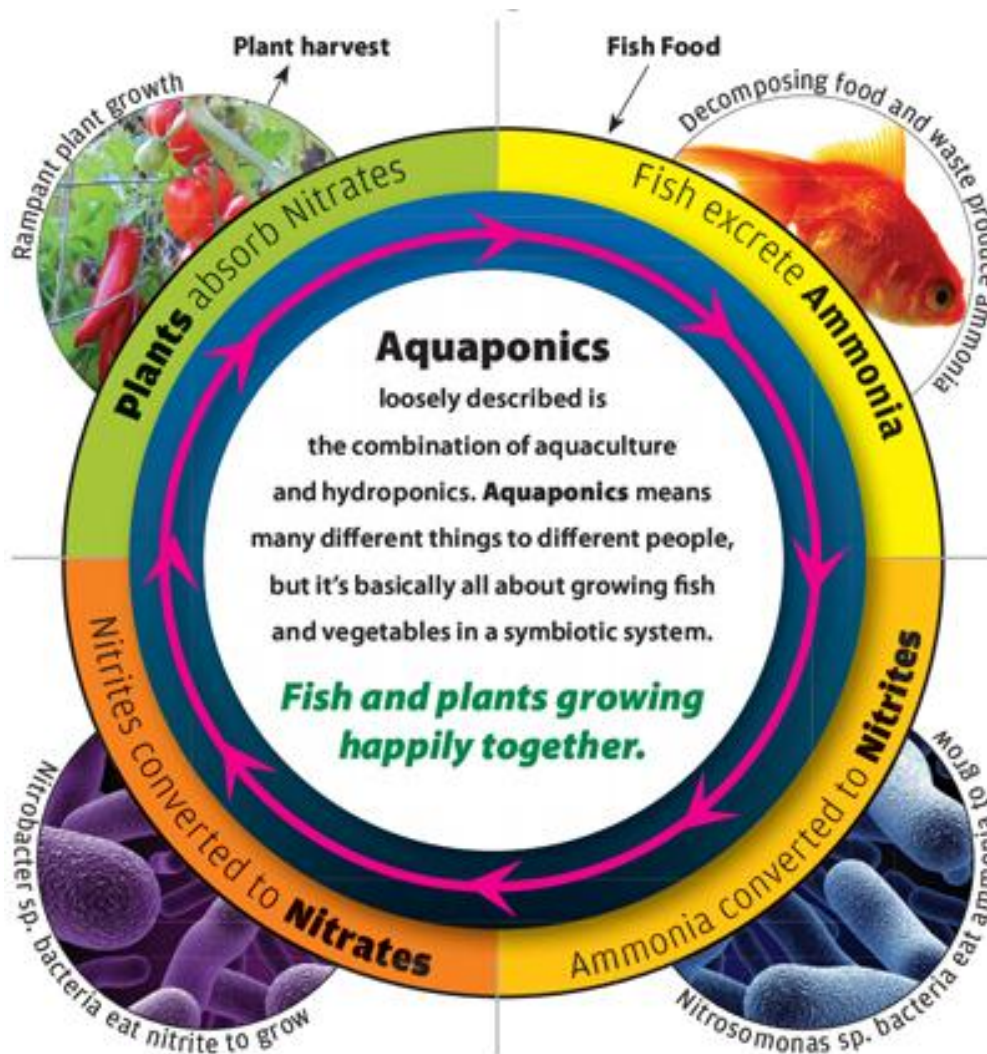

Figure 1: The nitrogen cycle in an aquaponics system [3]

### 2.2.2. Simple example<sup>1</sup>

It is in fact a near self sustaining ecosystem which requires minimal input and includes live bodies within an ecological cycle (Figure 2):

- Fish are fed and produce excrement rich in nitrogen (ammonia  $\text{NH}_3$  and urea), phosphorus and potassium. This excrement is the source of nutrients for the plants. Food given to the fish is put back into the water in the form of fertilizer (excrement) but the ammonia is toxic for the fish. We must filter the water to reduce/rid of the ammonia so the fish will survive.
- The water of the tank is pumped and sent to the tubs of culture where plants/vegetables are grown in a neutral substratum expanded clay balls. Complex



<sup>1</sup>Reference for Simple example part: [52]

natural reactions are set up alone: Bacteria transforms ammonia into nitrites then nitrates.

- Plants can use the nitrates and absorb them by their roots.
- This produces a natural filter which clears the water of its toxic components.
- The clean water is sent back to the tank.
- The water on return will at one point be open to the air to oxygenate it (this oxygen will be useful for the fish, plants and bacteria).

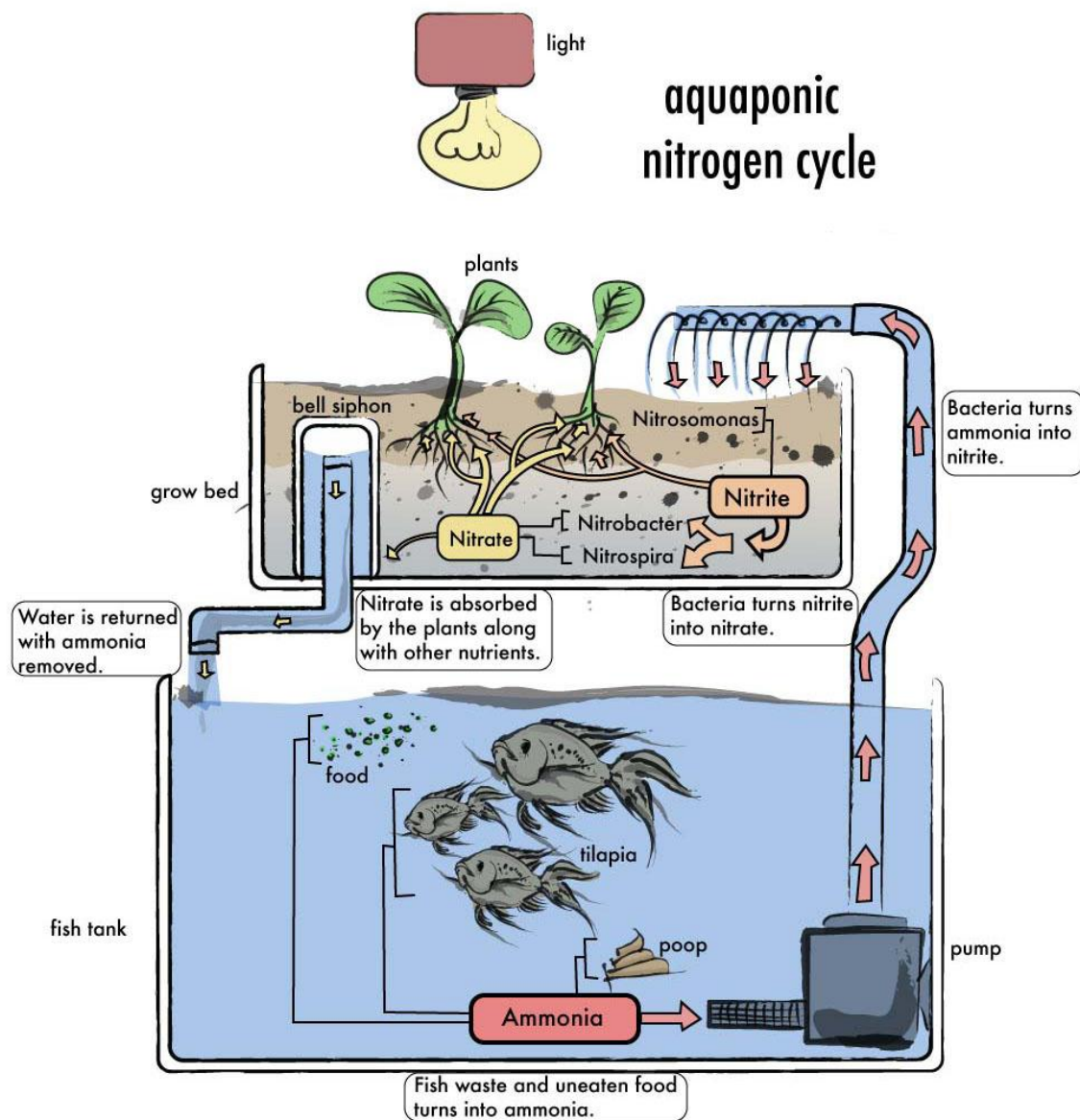

Figure 2: Simple functioning example of an aquaponics system [4]

## 2.3. Components<sup>2</sup>

There are basic components that every aquaponics system will need, regardless of the type of aquaponics system we set up. There can be some variation in what we actually use for each component, usually dependant on how much money we want to spend. we will need the following for an aquaponics set-up.

### 2.3.1. Fish Tank

We can use an aquarium, a pond/pool, a used food-grade container, a barrel/drum; basically anything that will hold water and can hold fish without being poisonous to the fish. The size we need will be dependent on the amount of fish we are going to keep and whether we want them as an integral part of the system or to grow out as food.

### 2.3.2. Grow Beds

What we use will be determined by the type of system we set up, so we will decide once we know what system set up we are using. There are three types of aquaponics systems: media-based, NFT<sup>3</sup> and deep water/raft. Depending on the system, we could need rain guttering, half barrels, styrofoam sheets, PVC<sup>4</sup> pipe/channels, buckets/plastic containers.

### 2.3.3. Growing medium

Again, this will be determined by the type of system we have. Aquaponics systems do not use soil so we need to have something else to support the plants as they grow as well as hold some water, if we are using a media-based system.

### 2.3.4. Pump

A water pump is needed to circulate the water from the fish tank through the grow bed and back to the tank.

### 2.3.5. Tubing

Tubing is needed to carry the air and water through the system. Water pumps generally use half inch tubing while air pumps are set up for quarter inch tubing. Plastic tubing is available in both clear and black; black tubing deters algae from growing and clogging the tube. Drip irrigation systems use quarter inch tubing and this is very good for aquaponics. It is very durable and cheaper than what is available in aquarium supply stores.

### 2.3.6. Timer

Some systems require a timer to manage the turning on and off the water pump, as with an ebb and flow system. In a home aquaponics system, the timing is generally in half

---

<sup>2</sup> Reference for Components part: [57]

<sup>3</sup> NFT: Nutrient film technique

<sup>4</sup> PVC: Polyvinyl chloride



hour increments. This could be completed by the use of an Arduino system where we can control multiple electronic elements at once by using Inputs from Sensors placed within the aquarium.

### **2.3.7. Biological filter**

Whether we need a bio filter or not may depend on the type of system we have. An aquaponics system is just like an aquarium; good bacteria need to build up to convert dangerous toxins from the fish waste into less-harmful nitrites and nitrates. Gravel in the bottom of the fish tank is effective or we might need a separate biological filter. If we have gravel as part of our aquaponics system this can act as a bio filter but we could have the problem of needing to allow the bacteria to build up again after every time we change our growing medium.

### **2.3.8. Plants**

We can choose from a wide range of plants to grow in our aquaponics system and will have fun experimenting with different types. Start off with herbs and then move onto leafy greens like spinach, silverbeet and lettuce. Again, the type of system we use can influence the type of plants we can grow. Most experts advise against trying to grow root vegetables like carrots, radishes and potatoes.

### **2.3.9. Fish**

Fish are the other part of the process that makes aquaponic gardening work. We can choose to have decorative fish like goldfish or cichlids or to grow edible fish species like trout, carp or tilapia, the most common farmed fish worldwide. We must research the available fish species in our local area because it is important to source fish that are suited to our climate.

These are the basic components we will need when we set up our aquaponics system but what we end up using depends on the type of system we decide on. It is advised to start small so we can learn the art and science of aquaponics before investing too much time and money. As we gain experience, we can add more tanks and grow the size of our aquaponics garden and move up to miniature farms.



## 2.4. Different type of culture system<sup>5</sup>

There are three basic styles of Aquaponics systems. Each system have some advantages and disadvantages and may be preferred depending on the type of culture we choose.

### 2.4.1. Nutrient film technique

The NFT is a method commonly used in hydroponics, but is not as common in aquaponic systems. In systems NFT (Figure 3), nutrient-rich water is pumped into small enclosed gutters, the water flows in a very thin film down the gutter. Plants are placed in small plastic cups enabling their access to water and roots to absorb nutrients. The NFT is not really suitable for all types of plants, usually this will be booked to the leafy green vegetables, large plants have root systems that are too large and invasive or they become too heavy for the gutters.



Figure 3: Example of a NFT culture system [5]

### 2.4.2. Deep water culture

The DWC<sup>6</sup> (Figure 4) is based on the idea that plants float on top of water allowing the roots to hang in the water. This can be done in a number of ways. This is one of the most common commercial methods. The DWC can be implemented by floating a raft of foam on top of the aquarium, but the most common method is to have the fish in an aquarium and pump water through a filtration system, and then into long channels where there are floating rafts filled with plants on the surface of the water and the roots extract the nutrients.

<sup>5</sup> Reference for Different type of culture system part: [58]

<sup>6</sup> DWC : Deep water culture



Figure 4: Example of an DWC system [6]

### 2.4.3. Media filled beds (Figure 5)

Culture beds represent the simplest form of aquaponics. This method uses containers filled with media in place of the soil which ranges from foam to clay pebbles. Water from a fish tank is pumped into the beds of plants and the plants grown between the media and use it as a solid base.

This style of system can operate in two different ways:

- A continuous stream of water running through the media filled grow bed,
- Or by flooding and draining the grow bed.



Figure 5: Example of a media filled bed culture system [7]

### 2.4.3.1. Water circulation in MFB<sup>7</sup>

Many configurations are possible in aquaponics, this may be as simple as a pond with floating plants above, or complex using a connection of multiple pipes and tanks.

There are a few basic models that have been adopted and tested by many people around the world with each of these styles comes its own advantages and its own disadvantages associated with them.

➤ **Continuous flow (Figure 6)**

First of all the method of continuous flow, where the water is pumped from the fish tank to the grow bed and as is then sent back to the fish tank after moving through the grow bed. This is one of the simplest methods in aquaponics but has some disadvantages. Main disadvantages could include a fluctuating water level within the fish tank, a pump is required to be placed within the fish tank and not all nutrients are absorbed by plants and return to fish tank. To counter this, it may be possible to set up a system where the media is constantly moist at all levels not just the bottom so that the roots of the plants can take advantage of the water and nutrients. If there is no grid of irrigation, most of the gravel will remain dry and will no longer function as a bio-filter or an area of plant growth.

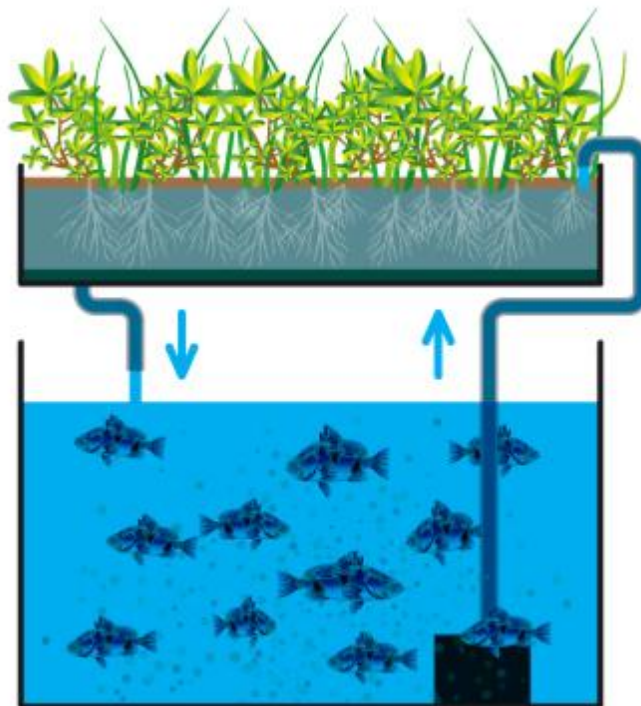

Figure 6: Example of continuous flow circulation [8]

<sup>7</sup> MFB: Media filled beds  
Reference for water circulation in MFB part: [53]





Another disadvantage is that standing of water as the system requires water to travel through a small area where there will be a large blockage from plants/growth media. A large grow bed plus a simple system of keeping all media wet is the main way to counter the disadvantages often seen within continuous flow growth.

➤ Flood and drain (Figure 7)

Almost the same as a continuous flow system. The grow bed lies above the aquarium; water is pumped from the aquarium to the Grow Bed; water flows back to return to the aquarium below. The only difference from the Continuous System is that the flood and drain system uses either a siphon or a stand pipe to flood the Grow bed then allow it to drain. If there is a problem with the pump or power, the water will drain whatever happens back into the aquarium. This remains the base for the majority of small urban Aquaponic farms.

By mimicking the natural cycle similar to the waves or tides, we can enjoy the benefits of having the grow bed flooded and drained completely, allowing oxygen to circulate in the root zones of plants, while limiting the accumulation of solids in the bed, due to the constant action of the surging water in flooding and draining the bed of culture. With the regular flooding of the grow beds, there has more potential growth for plants on the bed all while reducing the absolute need for an extensive irrigation network that covers the entire surface of the bed, a definite advantage in aquaponics.

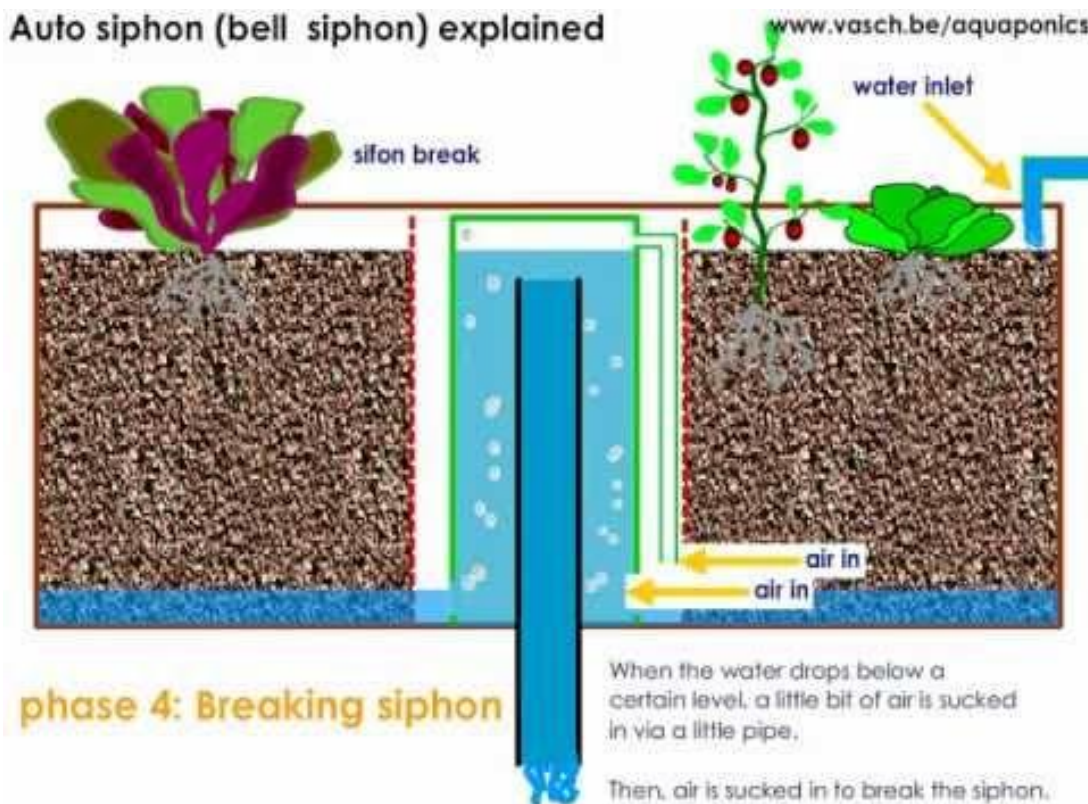

Figure 7: Example of flood and drain circulation [9]

In many trials of systems by many enthusiasts around the world, it was found that flood and drain aquaponics systems benefits outweigh the benefits of a flow-through system. This does not mean that continuous flow systems do not work. Many systems with continuous stream still work perfectly as can be seen with the Aquafarm (market leader in indoor aquaponics).

➤ Chift Pist (Figure 8)

Consisting of two fish tanks and the grow bed. Set up with one Fish tank below the grow bed (sump tank) and a second fish tank reaching to the height of the grow bed. Water is pumped from the sump tank into the main fish tank. This forces the water to rise in the tank and is sent through tubing to the grow bed. This tubing runs to the bottom of the main fish tank to pick up larger solids (known as solids lift overflow). The Water that has been pumped into the grow Bed causes it to flood and be continuously drained back into the sump tank below. A much harder system to design and not suitable for indoor aquaponics.

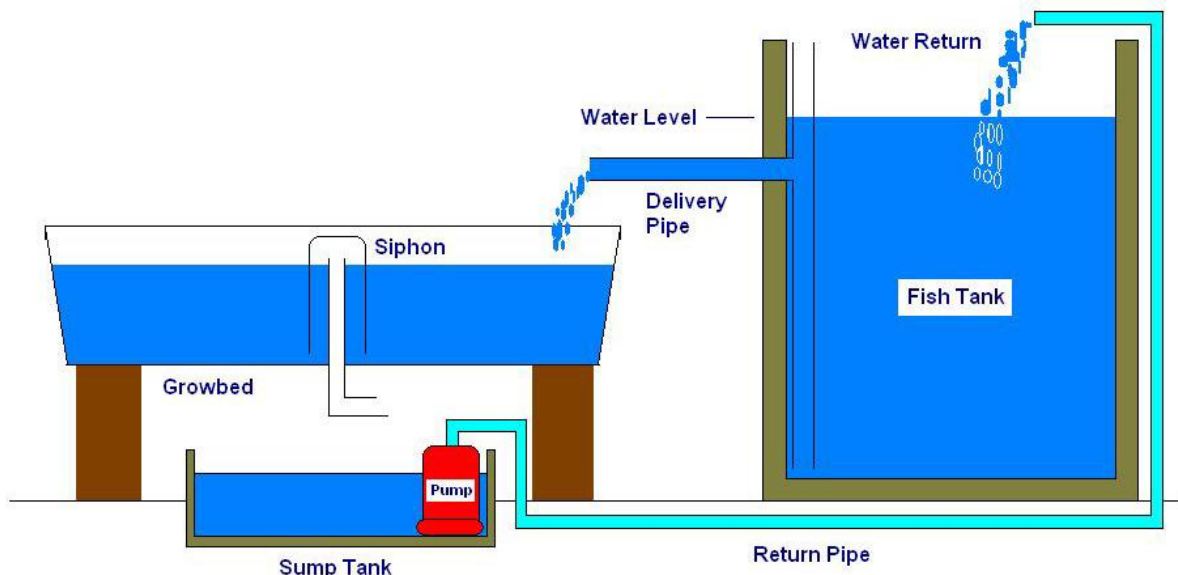

Figure 8: Example of Chift pist circulation [10]

2.4.3.2. Media for grow beds<sup>8</sup>

➤ There are several types of different Media that we can use in our aquaponics system.

First of all, there is gravel, for the size of the particles it's preferable to use gravel which are 16 mm or 20 mm, there are a few disadvantages to use different sizes. If the media is much smaller then there will be not enough space for a good aeration and oxygenation of the grow bed. If the media is much larger, our surface of planting of vegetables will be significantly reduced, so it will be much more complicated to design our aquaponics system.

<sup>8</sup> Reference for Media for grow beds part: [54]



Secondly, we have the choice often used in hydroponics of expanded clay pebbles. We must be very careful with regard to the use of gravel/rock as they often have high mineral and pH levels that can prevent the uptake of nutrients by the plants and be harmful to the system.

➤ **Media easily available for our aquaponics system.**

Types of rock available locally for us: River stones, shale, slag and many others. One disadvantage is rock or gravel media is very heavy and we must think about this when designing our aquaponics system and plan to have sufficient support for our grow beds. The benefits of rock media however are that it is readily available and generally very inexpensive.

The balls of expanded clay are extremely light, neutral pH and are sold in large bags. This makes them practical to transport, store and use. Also expanded clay pebbles are often seen as expensive compared to rock but for Indoor aquaponics the expanded clay is still cheap with the cost only being slightly more for such a small amount needed.

## **2.5. What plants can be used?<sup>9</sup>**

It seems that most of the herbs and vegetables adapt well to aquaponics. Of course, some plants will not work as well as with other methods. Grow beds with gravel or clay balls seem to be the most effective for the cultivation of a wide range of plants.

### **2.5.1. Vegetable roots and aquaponics?**

Although you probably would prefer your better potatoes to be grown in the ground, they can grow successfully by the use of aquaponics. The carrots are another vegetable whose culture is possible in a grow bed with the use of aquaponics. These vegetables require alterations to the simple methods shown but it is possible to grow them with the correct system and consistent temperature/sunlight.

### **2.5.2. Deficiencies within Plants?**

As with all gardens, deficiencies in plants are going to occur, but in general these can be treated very simply. Algae extract is an excellent way to compensate for the shortcomings of all minerals that may be lacking in an aquaponics system. Extract of algae exists in many different forms and it is important to take care not to use harmful additives, because everything that is added into the system will be forwarded to the fish, bacteria, plants and ultimately to the consumer. It is also possible to use powdered minerals. There are a number of them on the market, but again it is wise to pay attention to their ingredients if they were not used before as this could upset the system. The best way to combat deficiencies is to use a good quality fish feed. What makes good food for fish is the quality of



<sup>9</sup> Reference of What plants can be used? part: [55]

the bi-product composition, this means that there is a lot of minerals and trace elements in good fish food.

### 2.5.3. Can I plant seeds?

Absolutely. In the grow beds, there is typically a combination of plants and seeds. With the first plantation in a grow bed in a new installation, it is recommended to sow on the fly a mixture of seeds, as well as planting seedlings. The planting of seedlings is simple but it is recommended to use normal plants before planting seedlings.

With the planting of seedlings in the grow beds, the hustle and bustle of the gravel with the water flow lets seeds that were sprinkled on the bed fall between the gravel where it can absorb water and germinate safely. This method has many advantages: As the plants grow and shelter germinating seeds, they tend to dominate the bed and most germinating seeds can grow very slowly, however, once the plants ripened and harvested, this opens a window giving a chance to the small plants to grow. These plants now have a mature root system and have the right footing to grow very quickly. This mimics the natural forest ecosystems, where young trees and bushes grow very slowly, until large trees die and thus opens the canopy allowing light to seep for lower lying plants, which then stimulates their growth as a race to be the dominant plant.

### 2.5.4. What is the rate of growth in aquaponics?

The growth rate of plants in aquaponics systems can be quite phenomenal. The advantage of the aquaponics vegetables over vegetables grown in soil is that during the warm season plants get water as much as they need due to regular flooding of the Grow beds whereas in regular farming the land could go dry for an extended period of time.

Plants grown in the ground can use water around their roots very quickly in hot weather, which leads to wilting if there is a lack of water on a hot day. In an Aquaponics system, plants are watered continuously, so that they always have water, regardless of the ambient temperature.

## 2.6. Fish within aquaponic systems<sup>10</sup>

### 2.6.1. The importance of fish in aquaponics

Fish are the motor of your aquaponics system, they provide nutrients for vegetables/plants and if your fish are edible, they also provide a source of protein. Raising fish can be a little intimidating for some, especially those without any previous experience, but you should not be discouraged. Raising fish in an Aquaponics system is simpler than



<sup>10</sup> Reference for Fish within Aquaponics system part: [56]

raising them in an aquarium, as long as you follow simple instructions, then the growth of your fish will be healthy and possible to eat if desired.

### 2.6.2. Choosing the correct species of fish

There are many different species of fish that can be used in an aquaponics system. The fish should be chosen depending on the temperature of the water in which they will live and obviously the ease of supply. It is common in some countries of seasonal production of fish. In Australia for example, aquaponics systems are widely used and it is not uncommon to see the farming of trout in winter and Barramundi or Tilapia in summer. There is also the possibility to use only one species that can live both in summer and in winter, but these fish take in general more time to grow. In France the Trout keeps steady growth throughout the year and are common in our country. Worldwide, the most used fish are Tilapia, the Barramundi and Nile perch. These three fish require a heated water.

To decide what may be the best species of fish to raise for you, you need to take a few factors into account, the most important is to know what you want to make your system. If you do not want to eat your fish, then you'll probably not want to raise edible fish, or you might want to raise edible fish that can live year-round in your area, so you won't have to change according to the seasons. The second most important factor is 'what is available?' You must be able to buy fish to keep using your system, even with species such as tilapia, which grow rapidly, you need to keep a good supply.

### 2.6.3. Number of fish

This is a subject of debate among people who practice aquaponics. Levels of fish stocks in a system can be as high as in intensive aquaculture, but if the density is high there is more probability that things can go wrong. In high density you need to keep a constant eye on all parameters of the water to be sure that the conditions are maintained at the optimum level. If you lower the levels of fish stocks you reduce your risk. The rates of growth of plants in the slightly dense systems may still be very impressive.

## 2.7. Starting the aquaponics system<sup>11</sup>

There will be many ways in which we can create a successful system. We must always remember that in an aquaponics system we need a 'cycle' system, which means we must establish our population of bacteria in the system so that they can convert the ammonia into nitrates to allow vegetables/plants to grow.

It would be beneficial to use an existing tank where natural bacteria has already grown and developed but as we are creating a new system then we must allow time for the bacteria to grow so that it can alter the ammonia into nitrites and nitrates so the plants can

---

<sup>11</sup>Reference for Starting the aquaponics system and Cycling the system parts: [59]

use these and grow. Without this bacteria, fish cannot be introduced as the filter will not work and this will be harmful to the fish population. It is possible to encourage this bacteria through certain grow bed media.

We have to keep in mind that the most important thing is to get a 'cycle' system, it is a good idea to allow our system to run about a day or two before the introduction of fish or before making long-term plans mainly because we must ensure that the system works well and that there are no leaks or other potential problems that can be harmful to the fish.

## 2.8. Cycling the System

### 2.8.1. Urea-based fertilizer

A method to add a source of ammonia to assist in the establishment of our beneficial bacteria colonies is to use urea fertilisers, generally available in gardening, hardware stores or nurseries. It is a fairly simple method for a cycle system but we must be careful about the dosage and regular water analyses are recommended.

### 2.8.2. Ammonia

Household ammonia may come from several different sources. As with urea, special precautions are necessary to ensure that we do not exceed the critical dose for our system. We also must ensure to use only ammonia that does not affect food quality, there are many industrial ammonia for cleaning that tend to be scented or contain other additives.

### 2.8.3. Dead Fish/Crustacean

It involves placing a little fish or rotten crustacean in our system to allow ammonia emission which will feed our bacteria. Simple as it is a natural source of ammonia.

### 2.8.4. Fish food

We can start our aquaponics system cycle by introducing fish food that we will use to feed our fish in our system, food will begin to break down on the bottom of the basin, this release of ammonia will cycle into our grow beds and allow bacteria to grow.

### 2.8.5. Urine

Yes it's strange, but some people start their aquaponics system and the cycle by adding urine. Urine contains urea and urea breaks down into ammonia. This method is not suitable if any medical substances are currently being used.

## 2.9. Conclusion

There are really no limits to the ways in which we can design an aquaponics system. However it is recommended to start with a simple system, so that we can get an idea of how it works before trying more complex methods. Methods of flood and drain are much more



favorable than the continuous flow methods and we will look into how we can use this method within an indoor system.

The main decisions to be made are the fish and plants that are to be used within the system and whether both or one will be consumed. As we are looking at a small indoor system it would be wise to use the fish as a view only part of the system as they are often kept as pets.

# Chapter 3

---

## 3. Project management

### 3.1. Scope

The main scope in this project is a food production system/household aquarium: A compact aquaponics system that you can have within the home. The result must be a functioning and aesthetic system. This means fish and plants that can both grow and survive in a system that requires little extra maintenance compared to a simple aquarium. To ensure a high quality final product, we must:

- Have an aesthetic design.
- Create a suitable User Manual.
- Create the product while being as sustainable as possible.
- Maintain high quality ideas.
- Ensure an easy to use product following the manual.
- Ensure the product is safe to use for both the user and fish.





### 3.2. Time

We have to manage our time accordingly and try to follow the Gantt Chart where possible. Any changes to the time management must be changed on the Final Gantt Chart (Figure 9). Time must be allowed for possible errors that can occur.

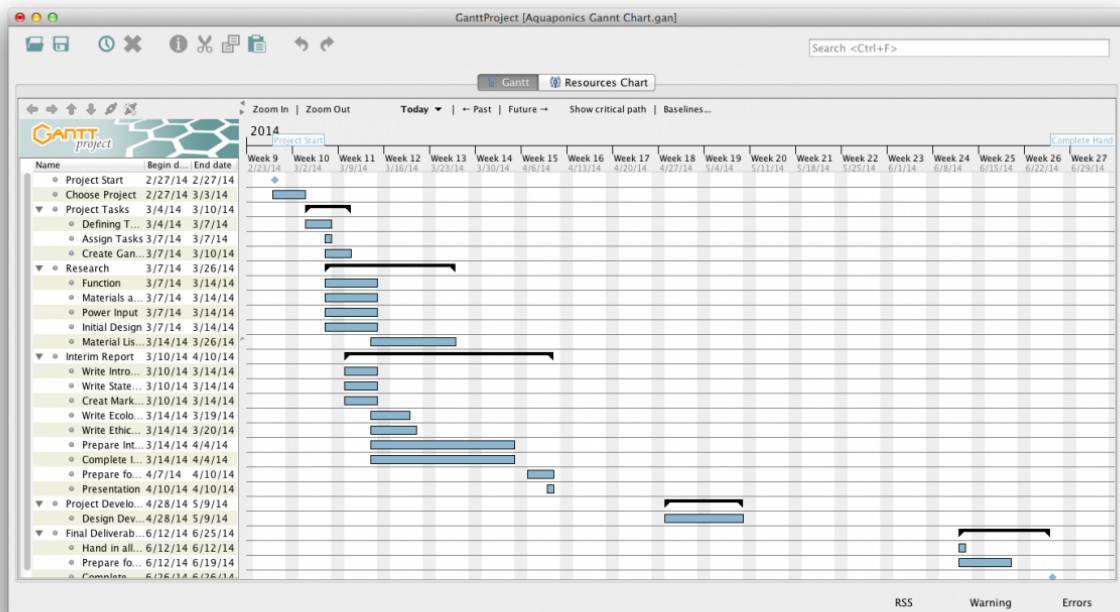

Figure 9: Team 5 Gantt Chart

### 3.3. Cost

Budget for the group project is 250 euros and this will be used only for the manufacture of the final prototype.

- Stay under budget if possible.
- Budget is for the group project only and not personal use.
- Use low cost solutions where possible.
- Reuse some components from university.
- Use group decisions on large cost items.

Our aquaponic system is a prototype but if we want to sell it then the price will change to be competitive in the market and afford all the personal cost, packaging etc.

### 3.4. Quality

Make sure the product is finished to a high quality. To ensure this we must:

- An effective plan incorporating a quality design.
- Approach all problems that arise within the project.
- Complete tests of whole system including electronics.
- Ensure that our design/solution works effectively.

### 3.5. People

To work effectively as a team we decided to split the project according to individuals strengths. In the Table 3 we see can see how topics were split accordingly.

Table 3: Work's distribution

Part concerning	Members
Technology and management	Gwen and Anna
Communication and marketing	Natalia, Arlene and Sean
Ethics and deontology	Anna
Design and modeling	Sean
Sustainability	Sean and Gwen

### 3.6. Communications

Regarding communication between team members we are arranging meeting by a private Facebook group but our confidential information is never used in this communication network. To share all the documents and the report we set up a shared Dropbox folder with all members of the group involved. We are able to easily access and alter shared files and every member can see it at one.

Regarding communication between the team and supervisors we set up three ways to share final documents and give feedback. This communication was through the following:

- Wiki document
- Weekly meeting
- Email



### 3.7. Risk

A company must think of all areas when it comes to risk and creating a new product. These risks can often have a large impact on the final design and this must be taken into account. It is important to evaluate all possible risks involved. The following Table 4 shows the main risks involved within our product, including the probability and overall solution.

Table 4: Risks and solutions

Main risk	How it occurs and likelihood	Risk solution
<b>Prototype may not work</b>	For some reasons, the ecological system and the electronic part could not work.	We need to prepare the prototype earlier to ensure all parts work together and individually.
<b>Water leakage from Grow Bed</b>	Problems within the electronics or water removal stand pipe cause the water level to rise.	To ensure this is not a problem we installed a fail safe water removal pipe that will quickly drain the water above a certain level.
<b>Broken part (tank or grow bed)</b>	Parts of the product got damaged within manufacture.	Ensure constant quality control checks on all parts.
<b>Team members Health/Fitness</b>	When a team member becomes ill or injures themselves.	Adjust the work load so that the other team members complete all necessary work.
<b>Communication problems</b>	Through missed notifications of updates on the group	Need direct contacts including (phone, email, text)

### 3.8. Procurement

We have the responsibility of obtaining all the components that we need to build our aquaponic system. To do that we must compare the cost of all items against quality. Due to restrictions we were only allowed to use local Portuguese shops and websites however we found that our project could of been completed at a lower price if we had used International sites.

If we want to sell our product and produce it we have to:

- Maintain high quality of all components.
- Ensure a constant income of components at a high quality and low cost.
- Be well organised during manufacturing.

Furthermore, we must develop and review our aquaponics system and the manufacturing to find whether the product can be made cheaper/faster in order to save costs where possible.



### 3.9. Stakeholders management

During this project people have worked on the aquaponics system, others have advised and helped. All these people have influenced the course of the project and should be considered as stakeholders. In the following Table 5 you will find different suggestions and expectations from these stakeholders.

Table 5: Stakeholders' expectations

Stakeholders	Expectations
<b>Team members</b>	Anna Wants that the aquaponics system works. The water flow has to be good in order to provide the fishes and plants with good living conditions. Furthermore, the electronic system have to give the correct information of pH and temperature.
	Arlene Would like the system to work, with the micro controller and sensors operating as desired. Would also like the product to look good and professional.
	Natalia Wants the system to have an attractive design and be easy to maintain.
	Gwen Wants that the aquaponics system works with or without sensors and build an other system in his own house
	Sean Wants the system to work by using an Arduino as a precoded controller and be able to sit within a household and not be out of place aethetically
<b>Supervisors</b>	Want the students to understand the process of a project and how to connect each part effectively.

### 3.10. Conclusion

Management is the “art” of organization and logistics. In order to work in a project team you need to have good organisation to keep the project moving forward. Teamwork doesn't lead and plan itself so we divided the project into topics and gave some of them to each team members. Overall we believe good management to:

- Control the budget and the quality.
- Be aware of all risks as possible.
- Divide teamwork evenly.
- Define different scopes and procurement.



# Chapter 4

---

## 4. Marketing plan

### 4.1. Introduction

In times of continuous development the environmental sustainability is a common concern of humankind. We are threatened with pollution and lack of the natural resources: water, food etc. Due to that modern marketing approaches focus on environment and ecology. Therefore our aquaponics system should fit perfectly in the 'green marketing' approach popular right now. The aquaponics system itself is considered to be an ecological food production system but the benefits of the product we offer are not only connected to the environment. The system allows people to save their time and money during cooking. In the end, thanks to the great design and modern devices that are included into our system, people can also show it off to their friends and gain additional points at the rat race in which we all constantly participate in nowadays.

### 4.2. Market Analysis

#### 4.2.1. Current market situation

There are few aquaponics systems available on the world market right now. Depending on size, they are made to work as portable farms which people can have either for personal use or to sell the fish/plants they cultivate. We can also differentiate outdoor and indoor aquaponics systems. While there is a wide range of outdoor aquaponics (usually for backyard or industrial use) there is not many to use indoor. So, we would like to introduce to the European market, an aquaponics system to use indoor that will be not only functional but also extremely aesthetic. What makes our product unique on the market is its decorative design. All indoor aquaponics systems available to buy are produced only to work properly – not to decorate the interiors of the houses.

#### 4.2.2. PEST<sup>12</sup> Analysis

Before creating a marketing plan it is important to scan the external environment. The tool to perform this task is the PEST analysis, which is an investigation of the political, economic, social and technological influences on the market (Figure 10).



---

<sup>12</sup> PEST: Political, economic, sociocultural and technological factors

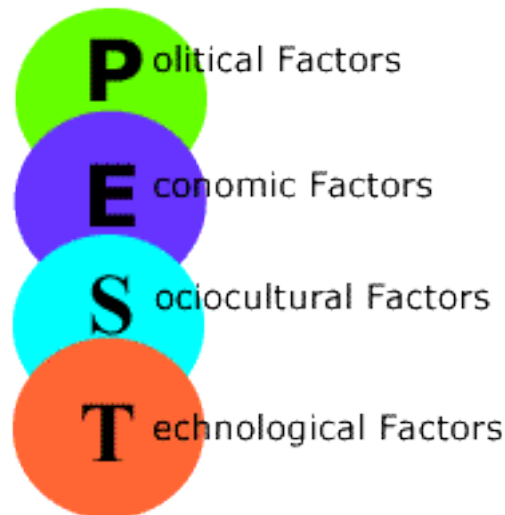

Figure 10: PEST analysis diagram [11]

As aquaponics systems can be classified as the production of organic food, we will analyse the market in terms of organic farming.

#### 4.2.2.1. Political

Organic food production is a self-regulated industry with government oversight in some countries, distinct from private gardening. Currently, the European Union, the United States, Canada, Japan and many other countries require producers to obtain special certification based on government-defined standards in order to market food as organic within their borders. In the context of these regulations, foods marketed as organic are produced in a way that complies with organic standards set by national governments and international organic industry trade organisations. [12]

As our product will be only for domestic use we do not need to obtain any certifications.

#### 4.2.2.2. Economic

Global sales of organic food have grown about 170 % since 2002 and it reached \$ 63 billion in 2011 (Figure 11). Certified organic farms are less than 2 % of the whole farming sector and they are unable to satisfy the increasing demand for organic products. Organic products usually cost from 40 % to several times more than price for the similar conventionally grown plants.

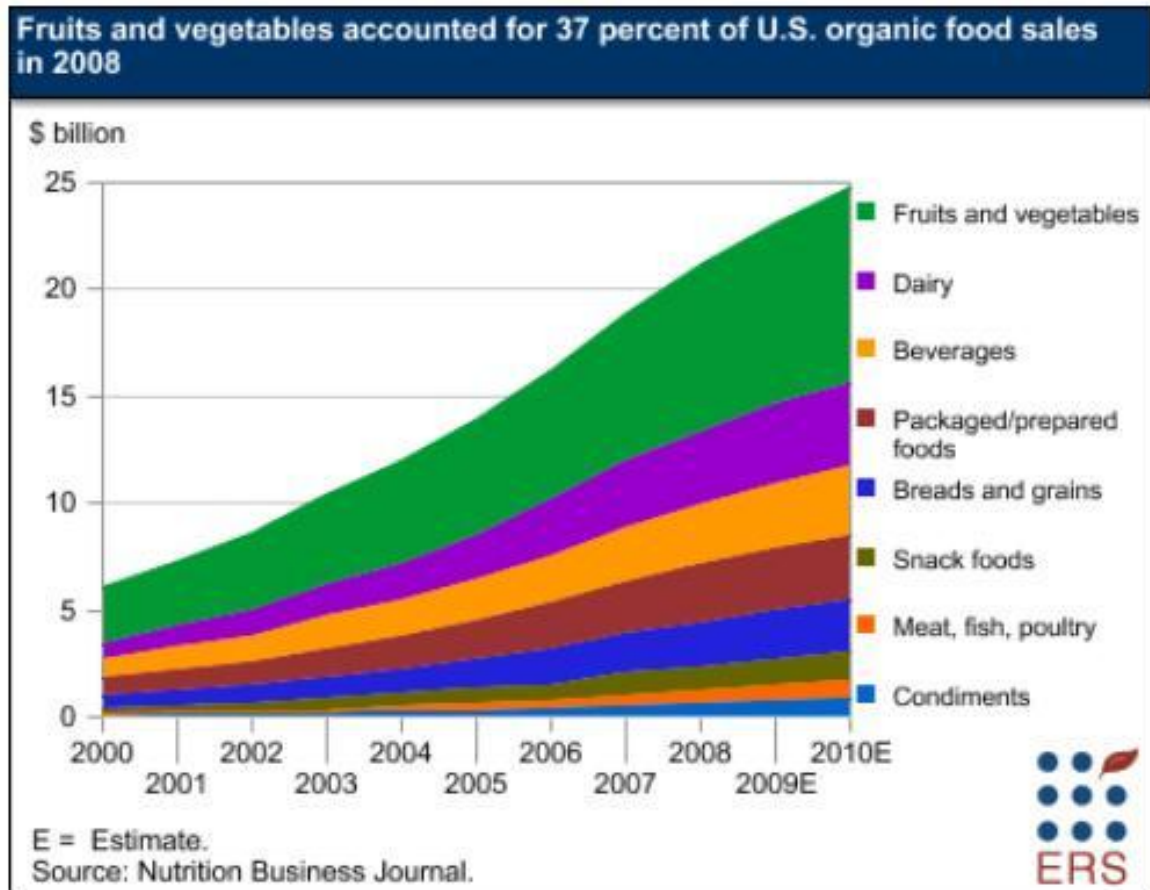

Figure 11: Organic food sales [13]

Since on a worldwide scale the demand is higher than the supply, there is a gap in the market that could be partially filled by our domestic aquaponics system. Plants grown in our system are not only organic but also a lot cheaper than those available in the shops.

#### 4.2.2.3. Social

Organic food producers made people believe that organic products are safer for their health and taste better. Because of that people are willing to pay more for organic products than for the conventional stock. In fact, there is no scientific evidence of their beneficial impact on the human body. [14]

However, the demand for organic foods is not only driven by concerns for personal health and for the environment. Since the ecological factor is very 'fashionable' right now people tend to improve their social status by buying bio-organic food. That also makes our product more attractive to the market.

Besides, modern society lives move at such a fast pace that every minute of the day is important. Thus, with our domestic aquaponics system, people are able to get fresh herbs or plants without wasting time on shopping.

#### 4.2.2.4. Technological

Our domestic Aquaponic system can be considered as a health or food gadget. It is equipped with many sensors and an LCD allowing the user to monitor every parameter of the system. The main object of using technology in our houses is to save time and make life easier. Since our system is self-sustainable, it meets modern technological trends

#### 4.2.3. Competition

Our main competitors are three companies offering their products online:

- Back To The Roots ([www.backtotheroots.com/shop/aquafarm](http://www.backtotheroots.com/shop/aquafarm)).
- Backyard Aquaponics ([www.backyardaquaponicshop.com](http://www.backyardaquaponicshop.com)).
- Nelson Pade's shop ([www.aquaponics.com](http://www.aquaponics.com)).

From what we know there are no commercial producers of aquaponics systems in Europe.

##### 4.2.3.1. Back to the Roots

Back to the Roots is a US company established by a group of Berkeley students. In their online shop they offer for sale two products: one is the Mushroom Kit (to grow your own mushrooms) and the other one is the aquafarm (Figure 12) which they describe as a "Self-cleaning fish tank that grows food".

In fact, it is a small, fancy, indoor aquaponics system working similarly to our prototype. The difference between the aquafarm and our aquaponics system is the use of modern technology. Our prototype is equipped with a bunch of electronic devices making our system more attractive and easier to maintain.

Since the aquafarm is the only domestic aquaponics system offered for sale worldwide, Back to the Roots is without a doubt our strongest competitor on the market.

[15]





Figure 12: Back to the Roots' aquaponics system [16]

The price of the aquafarm is 59,99\$ that is equal to around 44€.

#### 4.2.3.2. Backyard Aquaponics

Backyard Aquaponics is a leading edge aquaponics company launched in Western Australia. Initially it was just a group of people offering support and information for people interested in the subject of aquaponics. Today, the company is still a well-known provider of books, magazines and DVDs concerning the topic but it is also a rapidly developing online store offering a wide range of aquaponic systems. Backyard Aquaponics provides a worldwide shipping only for some of their products. The rest is available in their retail store located in the Western Australia. [17]



Figure 13: Aquaponics system by Backyard Aquaponics [18]

The cheapest and the smallest system offered by this company is the balcony aquaponics for 995 dollars (Figure 13).



### 4.2.3.3. Nelson Pade's Shop

Nelson Pade’s shop is a family company from USA that have been designing and researching aquaponics systems for nearly 25 years. They launched their online shop in 2005 and they are still expanding. The shop does not ship their products outside of the USA. [19]



Figure 14: Aquaponics system by Nelson Pade's Shop [20]

The smallest and cheapest product is an aquaponics system for use at home or school priced around 3000 dollars (Figure 14).

## 4.3. SWOT Analysis (Table 6)

Table 6: SWOT analysis description

Strengths		Weaknesses	
Product is easy to use		Young and inexperienced development team	
Using new technologies		No reputation on the market (new company)	
Self-sustainable		Limited budget	
Eco-friendly		Limited time to develop our system	
Plants cheaper than in the stores		Design can become unfashionable very quickly	
Decorative modern design		Balance of the system can be easily disrupted	
Requires little time to maintain			
Opportunities		Threats	
Expansion outside the Europe		Product disregarded on the market	
Obtaining European Union funding		Copying (or improving) our prototype by bigger companies	
Introducing the product to the Third World Countries		Launching of worldwide shipping by our competitors	
Further development of the product, for example:		Healthy and ecological lifestyle trend will go out of fashion	
	<ul style="list-style-type: none"> <li>• Implementing wireless connection between sensor monitoring the system and computers (e.g. wi-fi)</li> <li>• Producing outdoor Aquaponic systems</li> <li>• Enabling customers to customize the design of our product</li> </ul>		



#### 4.4. Strategic Objectives

Our marketing plan is designed to achieve the following strategic objectives in the next 3 to 5 years:

- Development of the communication module (connecting with sensors via wi-fi).
- Expansion to Asian and African markets.
- Establishing and maintaining long-term customer relationships.
- Obtaining European Union funding.
- Introducing new design of the product in accordance to current trends.
- Further improvement of our system and the company.

#### 4.5. Segmentation

To identify the target customers we divided the market into subsets of consumers who share the same or similar needs and priorities. We used criteria presented below:

- Geographic
- Demographic
- Lifestyle



Figure 15: Targeting subsets of consumers [21]

#### 4.5.1. Geographic segmentation

There are three regions in the world where organic food production gained popularity during the last 15 years - the USA, Australia and countries of the European Union. Since our main competitors are operating within the Australian and American market, we have chosen the countries of the EU as our target region. Another reason for choosing the EU countries are simplified transport procedures within the borders of the EU. As for now, the place of our production is located in one of European Union's countries and our system will be available only to buy online so shipment duration and costs will be lower in comparison to the worldwide shipping.

#### 4.5.2. Demographic segmentation

Demographic segmentation is performed by dividing market into groups based on:

- Age
- Income
- Lifestyle

##### 4.5.2.1. Age segmentation

We target our product at people aged from 16 to 65. Our product is designed to use in the kitchen and to decorate the houses, thus we aim at people who run their own households or simply are able to cook.

##### 4.5.2.2. Income segmentation

On the one hand, we aim our product at price sensitive buyers since cultivating organic herbs in our aquaponics system is cheaper than buying the same products in the store. And on the other hand we also target at people who owe extra money and are willing to spend it for exclusive house decoration or modern technologies.

Other demographic segmentation factors such as gender, occupation and education are not analyzed because of their none or negligible influence on the demand for our aquaponics.

#### 4.5.3. Lifestyle segmentation

As for the lifestyle, we aim at people that want to live in accordance to modern health and ecology trends. Our targets are also societies with rather busy lifestyle because our product is also considered as a time-saving home equipment.

### 4.6. Strategy/Positioning

Positioning is an essential part of the marketing strategy. Positioning is something that influences minds of the target market. It is the aggregate perception that market has of a



particular company, product or service. [22] Although the positioning of a product in people’s minds will happen irrespective of company’s activity – it will happen even if the company is passive, the certain marketing actions can have positive (or negative) impact of how our product is received by the society. Therefore, our aquaponic system must be perceived as unique on the market and satisfy the needs of the target we have chosen. To achieve these objectives we need to execute three types of product positioning related to: [23]

- Functional position
- Position based on the consumer values
- Experiential position

**4.6.1. Functional position**

Generally, functional positions solve problems and provide customers with benefits. In the case of our aquaponic system it helps people obtain fresh herbs every day without leaving their own houses or even kitchens. This makes cooking so much easier for our customers. Additionally, overall cost of the aquaponic herbs is lower than conventional ones. This is an another measurable benefit of our product.

**4.6.2. Position based on the consumer values**

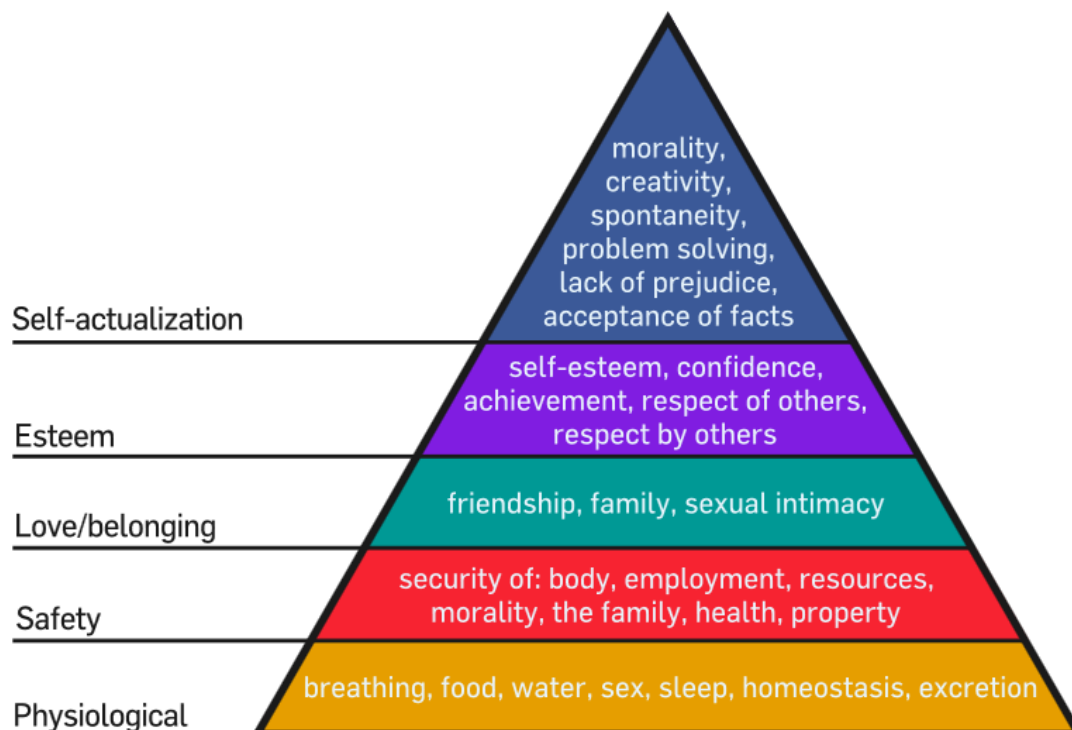

Figure 16: Maslow's hierarchy of needs diagram [24]



Since the second level of Maslow's hierarchy of needs (Figure 16) includes health and morality our product can have a relatively high value for society. The plants cultivated in our aquaponic system do not require fertilizing and are considered to be much healthier and less damaging for human body. What is more, the whole system is perceived as self-sustainable and beneficial for the environment so it is also morality need being satisfied. As for the fourth level of the Maslow's pyramid which is respect by others, our product is very rare and new to the market so having it in the household means for the customers being unique and gaining the popularity among others.

#### 4.6.3. Experiential position

Experiential position is strongly connected to sensory stimulation. If our product has an attractive and visually appealing design it positively affects customer's sense of sight. Additionally, our aquaponic herbs have a strong impact on two other human senses which are smell and taste.

Market positioning process is also connected with positioning in advertisements. Our aquaponic system is targeted at two different segments of the market : one are people who like to cook and would like to simplify their everyday life and the other are people who would like to increase their social status by buying exclusive products that are using modern technologies. Since then, we should prepare two different advertisements approaches. As for the first segment, advertisements should emphasize that our aquaponic system is extremely helpful for cooking but also useful to save time and money. Drawing attention to always available fresh herbs and self-sustainability is our main objective for this segment. And for the second segment, our system should be presented as an exclusive, luxury product that can be used to decorate houses. In the advertisements addressed to the second target group, we should lay stress on presenting the unique design, sensors, LCD display, colorful LEDs and everything else that is connected with using modern technologies.

### 4.7. Adapted Marketing-Mix

To define the marketing mix for our aquaponics system we used the 4ps tool. The questions that helped us to analyze each of the four elements are presented after.



Figure 17: 4ps marketing mix example [25]

#### 4.7.1. Product

Product we offer for sale is a small domestic aquaponic system designed mainly for planting herbs. It consists of the fish tank and the grow bed for planting herbs at the top. The system is also equipped with modern technologies such as sensors, programmable LEDs and Arduino controller which differentiate our system among other aquaponic systems available on the market right now. Electronic devices included make our system very self-sufficient and as much sustainable as possible. Our system is adjusted to fit the typical small

spaces available in the kitchen (the dimensions of the tank are 40x20x37 cm) so that people could get their herbs without even leaving the room.

Additionally, the layout of our system is exceptionally decorative (the growbed and the bottom of the tank will be covered with the veneer to cover all the electronics and pipes) and very up-to-date so we may consider our aquaponics as a significant element of the kitchen design. As we will ship our product thorough the Europe it will be delivered to the clients in the carton box with our brand logo on it. It will be also secured with the bubble wrap to prevent damage during the way.



Figure 18: Our logo

#### 4.7.2. Price

The price of our aquaponic system must cover following costs: materials, medias and tools used, labor, packaging, advertising and profit.

Defining the price at this level of product development is very inaccurate and uncertain. We are creating a prototype from the materials available only in the district of Porto so the choice of suppliers is very limited. Thus, the prices are much higher than if we could get materials online or just outside the city. Also, we are making a retail purchase so the costs are higher in comparison to wholesale prices.

At the moment, materials we ordered cost around 280 euros. We cannot estimate media, labor, packaging and advertising costs currently since we haven't started the building process yet. The profit should be set at around 25 % of the total production cost.

As it was already said, we decided to target two different segments of the market – one are people that would like to save money on herbs and make cooking easier and the second are people interested in having a fancy fashionable kitchen gadget. The first segment of the market presented would be far more price sensitive than the other one so we must pay attention to keep the price level as low as possible.





Fortunately, even with the price at around 350-400 euros our product is very competitive on the market since two of our main competitors sell their product for more than 1000 dollars. Furthermore, we could offer a 15 % discount if the order would be made for more than 3 aquaponic systems. We could also organize weekly promotion and offer free delivery to different country every week. We must also keep in mind that the price will be much lower if we launch a mass production of our prototype.

#### 4.7.3. Place

In the first phase of establishing our company we will focus on direct distribution channels. Therefore, we will be able to get to know customers' needs and keep in close contact with them. We will as well do away middlemen and avoid additional costs of another layer between the manufacturer (us) and the client. By selling directly to the customers, we will be in better control of our aquaponic system's pricing and sales.

Nowadays, the most common direct distribution channel is the Internet. Not only it is cheap but also allows us to reach the customers located all over the world. That is why we have chosen it as our main distribution place. We will launch the Internet online store in a few different languages. To minimize the cost we will run the webpage by ourselves. For a start, we will provide a shipment to European countries but in the near future we plan to expand our activity outside this continent.

Eventually, we will also consider establishing a brick-and-mortar retail store or introducing our aquaponic system for sale in pet shops or supermarkets.

#### 4.7.4. Promotion

Promoting of a product has the significant influence on the customers' choices. Since our product will be offered for online sale, we will primarily focus on Internet advertising.

First of all, we will use the growing popularity of social media such as Facebook, Twitter etc. Creating fan page of our product and spreading the news online might work wonders for our system. Secondly, our company will also create a YouTube account with short movies presenting how our system works and highlighting its advantages.

It is worth noting that those two advertising methods can be completely free of charge. Usually, on the social websites like Facebook the companies have two options : they can either open their fanpage for free and gather as many observers as they could or chose the easiest option and pay to Facebook for promoting their page among users. Typically, the second way is more successful and brings results faster. That is why we will opt for payable advertisements.

We also noticed that blogs are becoming more and more powerful advertising channels for many different products. Therefore, we would like our aquaponic system to be widely promoted by famous bloggers. We will send them our system for free in exchange for positive reviews posted on their sites.

In the future we will also present our aquaponics system at pet or ecological trade shows and fairs. Also if we manage to obtain bigger budget we will launch radio and TV advertisements all over the Europe.

- More information regarding promotion could be found in the part 4.8. Budget.

## 4.8. Budget

We have been given 5000 euros of marketing budget to promote our aquaponics system in the first year of our production. We decided to allocate money for the following purposes:

### 4.8.1. Creating and maintaining the website/online shop

As none of us has sufficient knowledge and skills to create the professional and eye-catching online shop, we decided to have an IT<sup>13</sup> specialist to do it for us. Although the payment for designing the webpage is made just one-time, if we would like to have it changed or updated we are obliged to pay for the separate service. Furthermore, we have to cover the cost of domain and server that we are going to use.

- Cost of a custom made online-shop: 900 euros.
- Annual maintenance fee (updates, domain, server): 400 euros.

### 4.8.2. Advertising through social media

We decided to focus on advertising via Facebook because it is the most popular social website and it offers the most reasonable prices. The cost of ads on Facebook are dependable on the amount of clicks or 'likes' you receive (the clicks and 'likes' have their variable prices for each) The advertiser sets the daily budget and the ads are --displayed until the amount of clicks or 'likes' will exhaust all the money.

- Cost: 2850 euros per year (8 euros per day).

### 4.8.3. Leaflets

We will print about 1000 leaflets and distribute them among few biggest pet shops around the Portugal. If this way of promotion brings positive results, next year we will hand out more flyers to the pet shops all over the Europe.

- Cost of 1000 leaflets: 400 euros.

#### 4.8.4. Trade show

The rest of the money will be used for trade show. Of course, with 450 euros left to spend we cannot afford to participate in the trade show by ourselves. Therefore, we will try to look for one or two partners to cooperate and join the show together.

- Cost of participating in trade show: 450 euros.

### 4.9. Strategy Control

The main purpose of strategy control is to monitor whether its objectives are achieved or not. It also helps the company to evaluate on the real progress made and compare the results with expectations. Controlling the outcome of the marketing activities enables the organization to respond effectively on changes happening in the micro- and macro-environment in order to obtain the most satisfying results. Evaluation of the plan's effectiveness needs to be based on measurable indicators such as sales per year, market share (in %), return on investment or rate of sales growth. All those factors should be controlled periodically (annually, monthly or weekly). To keep an eye on relations with the clients a company should conduct surveys and collect opinions about the product/service after purchasing. Any complaints or claims reported should be carefully examined and responded as quickly as possible.

### 4.10. Conclusion

Marketing is defined as “a process responsible for identifying, anticipating and satisfying customer requirements profitably”. [26] It means that without good market analysis and effective marketing strategy launching a new product to the market is very likely to be unsuccessful.

Understanding of the customers' needs allows creators to adjust the developed product to the people expectations as in the end there is no point in putting.

# Chapter 5

## 5. Eco-efficiency measures for sustainability

### 5.1. Introduction

Practised in a classic way, these two productions present big economic and environmental inconveniences. The agriculture requires important contributions in fertilizer and in water, which are broadcast in the earth with a bad yield: a large part of these contributions gets lost in the ground and does not benefit the plant, causing waste and pollution. The intensive breeding of fish generates a large amount of organic waste which threatens the environment when released. Combining these two cultures cancels out the negatives of each by working together.

### *The Three Spheres of Sustainability*

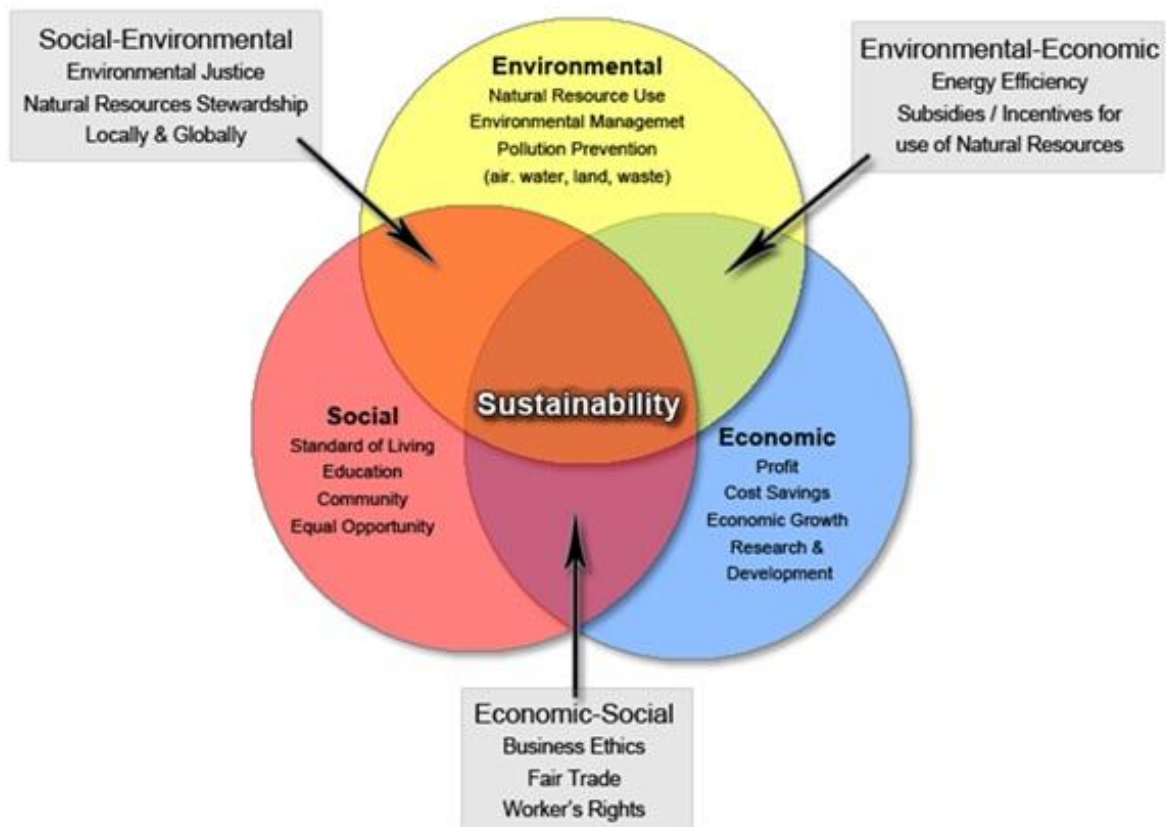

Figure 19: Three spheres of sustainability diagram [27]

## 5.2. Environmental

### ➤ Supporting a Culture will inevitably impact the Environment

The manufacturing of media for Grow beds includes energy: for extraction of raw materials; their transformations, which often includes high heat; the packaging; transportation to the final place of sale. A lot of this energy is used as polluting fossil fuels which are very harmful for the environment (CO<sub>2</sub>, NO<sub>x</sub>, SO<sub>x</sub>).

There is other one factor impacting on the quality of the water and the air. There is no ecological substratum, but only supports(media) of cultures, the manufacturing of which (or elimination) impacts more on the environment.

The future of the soil-less culture rests on the development of media that has little or no impact upon the environment.

The agricultural by-products of industries can establish horticultural media which is environmentally friendly: straw, linen, sawdust, wood bark, raisins and more.

These media types tend to settle gradually which reduces the aeration of roots. Some of these media types can also be unstable and could cause harm to plants as they break down. In order to find which natural media types are best it is wise to test on a large variety of plants to see different impacts.

As this type of media breaks down and creates a layer where oxygen cannot pass through more tests would be done to see benefits and negatives of this composting and weigh them against each other.

## 5.3. Economical

The Economical impact of aquaponics can be extremely large if done correctly. As with regular farming, aquaponics requires land in order to set-up the system. Initially aquaponics is very expensive with it's set-up costs compared to agricultural farming due to the need for tanks, piping, media, etc. But this initial cost is reduced by larger profit margins due to aquaponics allowing plants to grow faster and is an organic system with the plants being healthier than unnaturally fertilised plants. Couple this fast, healthy growth of plants with a large fish farm below and the aquaponics system is a two for one.

Agricultural Farming uses around 90% more water than an aquaponics system which has a large impact on the environment itself. This extra use of water along with the plants only being grown compared to plants and fish shows simply the benefits of aquaponics. It



increases profits by adding an extra product to sell while being more environmentally friendly in the long run.

Aquaponics is a step towards reducing food shortages within Third worlds and hot countries. The large difference in water needed means that as long as there is an initial investment towards the structure itself the system can run for very little and provide a lot to a large group. The reduction in water allows more water to be saved for the consumer and overall provide a healthier lifestyle incorporating organic food and an increased water supply.

#### **5.4. Social**

Organic Foods are still on the rise across the world. People nowadays look to healthy alternatives to cheaply manufactured/processed foods. With the world now looking to save money and eat well it is possible by combining to forms of farming at once. Organic plants/vegetables coupled with organic fish not reared in an overcrowded farm.

Knowing that what you are eating is healthy is a large part of buying the right food and with an aquaponics system it is possible for someone to have that within their own backyard/home.

The future is green and with the reduction of straining our natural resources. Aquaponics reduces the strain on resources by allowing the user to both breed and eat the fish within the system and grow/harvest the plants that are produced. This system is not completely sustainable but for the future it has a large reduction on key resources such as water. Requiring only 10% compared to agricultural farming.

Communities can now come together to farm for themselves in first and third world countries. The impact on a community could be massive by increasing both food and water supplies and by giving jobs to many if a large farm is required or necessary. Simple aquaponics systems can also act as a point of noticing someone's contribution to the community and be a stimulus for other Ecological adaptations within the way we grow our food and live our lives.

#### **5.5. Life Cycle Analysis**

The Life Cycle on an aquaponics system can be very sustainable if done correctly.

With the system itself it is important to reuse components from other areas. This can include large water barrels reused to hold the fish; Old PVC guttering to hold the plants and grow media; Bark for the grow media.



The system should be able to be reused repeatedly for a long period of time. If sourced correctly then the component should not wear down quickly and will last an extended period of time. However after a certain period of time these materials will begin to degrade and affect the water circulating in the system which can pollute the plants and fish.

The components may then be sent to a recycling facility to be put back into the system.

Small amounts of extras must be put into this life cycle including fish food and a water supply. However the fish food can be made from natural and renewable resources.

## **5.6. Conclusion**

Overall the aquaponics system can possibly be very ecologically friendly and sustainable. Through the correct set up and use of this system it can provide a large source of food for a community and have a small impact on the environment. The reduction in water use a large positive from using an aquaponics system.

However the initial costs for these systems can be expensive so investment would be needed for smaller and poorer communities. In the end it is obvious aquaponics has a large range of positives but coupled with a few negatives which can possibly put off many consumers.

# Chapter 6

## 6. Ethical and deontological concerns

### 6.1. Introduction

This chapter is to provide an overview of how ethics and deontology come into effect when engineering/designing products and more specifically our aquaponics system. Across the world Ethical and Moral rules differ greatly due to differences in laws and personal outlooks. When a product is designed, it must conform to all laws within the targeted market and be ethically/morally sound.

*“Engineers invent the future and their work affects the lives of millions of people, for better or worse. That raises enormous ethical issues in every branch of engineering”*  
[28]Page3

### 6.2. Engineering Ethics<sup>14</sup>

Engineering ethics is as much a part of what engineers in particular know as factors of safety, testing procedures, or ways to design for reliability, durability, or economy. Engineering ethics is part of thinking like an engineer.

#### ➤ Why?

To prevent tragedies, disasters, and scandals in which engineers have been major players.

We need analyze key ethical concepts and principles that are relevant to the particular profession or practice. Even if there are paradigms for, say, “safe” or “unsafe,” there are areas of vagueness and uncertainty. Algorithms that do justice to the ethical issues are hard to come by. Deal with ethical disagreement, ambiguity, and vagueness. The trick is to acknowledge that some disagreement and uncertainty can be expected and should be tolerated, however other views should not be disregarded completely.

Engineering is not just a technical or theoretical enterprise. Inherent in the exercise of engineering expertise is the provision of useful, if not essential, services to clients, employers, customers, and the public. Usefulness, quality, safety, efficiency, and cost effectiveness are not secondary features of this activity. They are its heart. The engineering work is not indifferent for itself, or for the rest of society. After all, progress is the

---

<sup>14</sup>Reference for Engineering ethics part: [51]





improvement of the human world, not only in the technical field, if not from a perspective that considers the quality of life.

➤ How?

Aquaponic engineers shall commit themselves to making the analysis, specification, design, development, testing and striving to increase the competence and prestige of the engineering profession. Using their knowledge and skill for the enhancement of human welfare[20]. In accordance with their commitment to the health, safety and welfare of the public, engineers shall adhere to the principles:

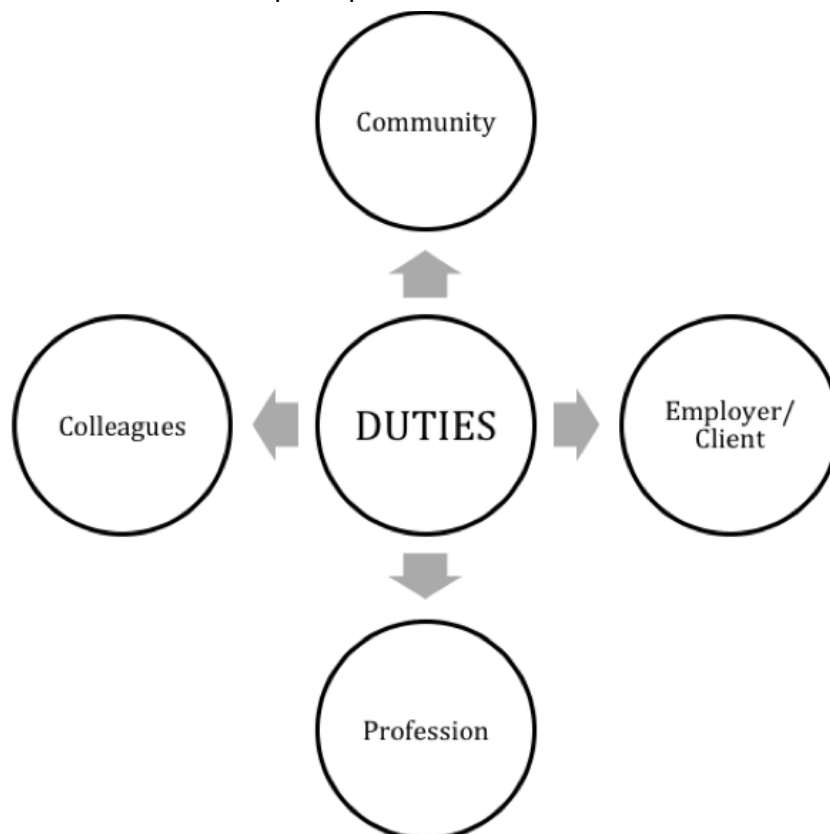

Figure 20: Duties diagramm

- **COMMUNITY:** Aquaponics system engineers shall act consistently with the public interest. Hold paramount the safety, health, and welfare of the public [29]
  1. Accept full responsibility for our work.
  2. Moderate the interests of the aquaponic engineer, the employer, the client the users and the fish.
  3. Approve the system only if we belief that it is safe for the users, fish and plants, meets specifications before the introduction of the fish, passing the appropriate tests, and does not diminish quality of life, diminish privacy or

harm the environment. The ultimate effect of the work should be to the public good. [30]

4. Disclose to appropriate persons or authorities any actual or potential danger to the user, the public, or the environment, that they reasonably believe to be associated with the system or related documents
  5. Be encouraged to volunteer professional skills to good causes and contribute to public education concerning the discipline.
- **CLIENT AND EMPLOYER:** Aquaponics system engineers shall act in a manner that is in the best interests of their client and employe consistent with the public interest.
    1. Provide service in their areas of competence, [29] being honest and forthright about any limitations of their experience and education.
    2. Not knowingly use aquaponic system that is obtained or retained either illegally or unethically.
    3. Keep private any confidential information gained in their professional work, where such confidentiality is consistent with the public interest and consistent with the law.
    4. Identify, document, collect evidence and report to the client or the employer promptly if, in their opinion, a project is likely to fail, to prove too expensive, to violate intellectual property law, or otherwise to be problematic.
  - **PROFESSION:** Engineers shall advance the integrity and reputation of the profession consistent with the public interest.
    1. Ordered the integrity and reputation of the profession consistent with the public interest.
    2. Help develop an organizational environment favourable to acting ethically.
    3. Promote public knowledge of aquaponic systems engineering.
    4. Extend aquaponic engineering knowledge by appropriate participation in professional organizations, meetings and publications.
    5. Not promote their own interest at the expense of the profession, client or employer.



6. Obey all laws governing their work, unless, in exceptional circumstances, such compliance is inconsistent with the public interest.
  7. Be accurate in stating the characteristics of system on which they work, avoiding not only false claims but also claims that might reasonably be supposed to be speculative, vacuous, deceptive, misleading, or doubtful.
  8. Take responsibility for detecting, correcting, and reporting errors and associated documents on which they work.
  9. Avoid associations with businesses and organizations which are in conflict with this code.
  10. Recognize that violations of this Code are inconsistent with being a professional engineer.
  11. Express concerns to the people involved when significant violations of this Code are detected unless this is impossible, counter-productive, or dangerous.
- **COLLEAGUES:** Engineers shall be fair to and supportive of their colleagues.
    1. Encourage colleagues to adhere to this Code.
    2. Assist colleagues in professional development.
    3. Credit fully the work of others and refrain from taking undue credit.
    4. Review the work of others in an objective, candid, and properly documented way.
    5. Give a fair hearing to the opinions, concerns, or complaints of a colleagues.
    6. Assist colleagues in being fully aware of current standard work practices including policies and procedures for protecting passwords, files and other confidential information, and security measures in general.
    7. Not unfairly intervene in the career of any colleague; however, concern for the employer, the client or public interest may compel engineers, in good faith, to question the competence of a colleague.
    8. In situations outside of their own areas of competence, call upon the opinions of other professionals who have competence in that area.



9. Conduct themselves honorably, responsibly, ethically, and lawfully so as to enhance the honor, reputation, and usefulness of the profession. [30]

### 6.3. Sales and Marketing Ethics

Sales and Marketing Ethics are a large part in retaining customers and building a solid brand image. During the sales and marketing processes/campaigns the product must be sold truthfully without tricking the consumer into buying the product/service. All marketing campaigns must be truthful when selling the product so that the customers trust the brand and will return to buy future products. With our aquaponics system a main marketing idea is that the system is very sustainable. However we must be truthful when marketing the product and say that it is only very sustainable backed up by facts such as that it only uses 10% of the water usually needed to grow plants due to the cycling system. In many cases throughout the net aquaponics is said to be 100% sustainable however this is untrue due to the several inputs required such as electrical power supply, fish food, water.

#### 6.3.1. Brand name

For the construction of a company identity we need a brand. Our brand have personality with the name 'Phish Phood' and the logo seen in Figure 21. It can not be similar to other brands that are already registered. This is to avoid copyright. We need to protect and register our brand, logo and slogan in the country that we want to sell it. For example, after researching the Intellectual property sites of Europe we can register our brand name/logo as it is not currently name.



Figure 21: Our logo

#### 6.4. Academic Ethics

When you are doing a work or an investigation you have to take in account the following values [31]:

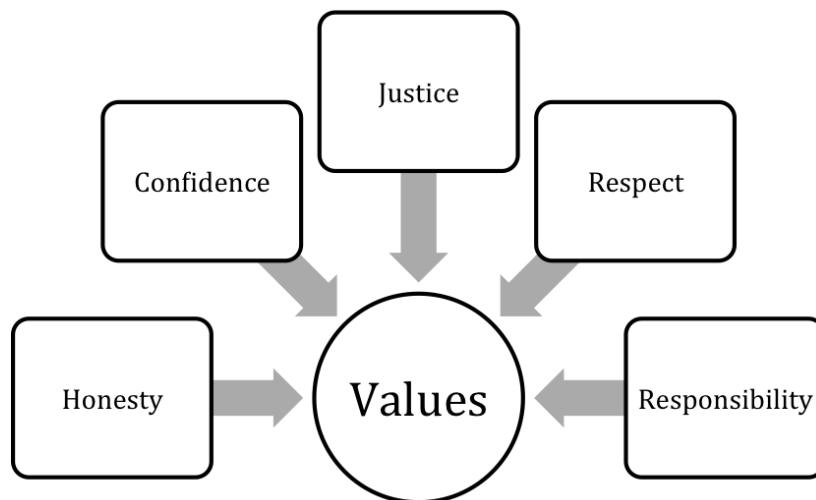

Figure 22: Values diagramm

These values are thought to preserve the copyright. It is really important to be transparent citing the sources of information. False or misleading citations of sources constitute plagiarism.

*“Plagiarism is the appropriation of another person’s ideas, processes, results, or words without giving appropriate credit, including those obtained through confidential review of others’ research proposals and manuscripts.”* Definition of plagiarism from the Federal Office of Science and Technology Policy, 1999 [28]



## 6.5. Environmental Ethics

It is the relationship that humans have with the natural environment. To design the aquaponic system, many environmental aspects have to be taken in account.

The principal objective must be that the environment is adequate for fish to be able to live and survive. To do that in the best way, it is necessary:

- Meet the nutritional requirements of the fish.
- Clean water frequently.
- Tank size. These animals breathe oxygen in the water, therefore it is essential that they have all the oxygen they need. They will be able to receive more oxygen from larger tanks.
- Correct pH.
- Right temperature.
- Good light.
- Decoration. Habitat complexity plays a much larger role in shaping aggressive behaviour than most other factors.

Environmental ethics must serve to not hinder future generations. We have to be responsible with natural resources that we are using. In our aquaponics system we want to use materials which can be recycled.

## 6.6. Liability

We are responsible for our project. It is an academic project with supervisors guiding us and we have to be clear about the objectives of our project and its purpose. For that, we have to respond with the expectations.

We must also consider our customers and respond to possible unexpected problems that may arise in our system. To show our understanding of our responsibility, we provide a warrantee. The warrantee promises the good condition of the aquaponic system and the states that we are responsible for repairing or replacing the product.

With the project, we have to be careful with our work to avoid problems of copyright. We need a patent to protect the technical part and also our brand and logo because everybody is going identify the company with the brand, logo and slogan.



Under no circumstances the product will endanger human or animal life.

### **6.7. Conclusion**

We will consider all code of ethics as this is essential for coexistence. We follow this code to avoid confrontations or irrational disputes. Without them we would have no basis for what is generally understood as good and bad actions or seen as acceptable to the brand.



# Chapter 7

## 7. Project development

### 7.1. Introduction

In this chapter we will cover the aquaponics system as a physical object, mechanical system and a system supported by electronic. We will look at the physical appearance of the system and how it is set up including all different materials/modules incorporated within the design. We will also look at how the system works within the design and how different aspects of the design affect the system's effectiveness. Then in the final, we will describe electronic components, why we chose these components and how they will work together in the system.

### 7.2. Architecture

This part is to present an overview of the different aspects that go into creating the system and physical design.

To get a full understanding of the system there will be multiple drawings/CAD<sup>15</sup> models to show how the design is set up and some simple flow charts to describe the system step by step within the design.

#### 7.2.1. Initial design



Figure 23: Our initial design

Our Initial Design (Figure 23) was aiming to be sleek and simple so that it wouldn't be intrusive to have within the kitchen or home. We looked at current designs and thought



about what we knew about fish tanks. The classic Goldfish bowl was a large influence on the original design as it was simple. Also, coming from design background it was key to follow current trends of modern styles which include organic shapes that have no sharp edges. This is where the cylindrical shape came into the design as it gave more space than the bowl. The tank being cylindrical meant that the grow bed should be the same shape to be easy on the eye.

In order to draw focus to the main aspect of the system being the fish within the tank two strips of plastic/veneer covered the base and grow bed. This would outline the tank and draw the eye to this area. Finally as we want the system to be technological and appealing to all consumers we decided to add LED strips to under the grown bed to add an extra focus to the tank. The LED's could change colour and cause different effects on the tank. The Grow Bed would almost completely cover the plant pots so just to see the plants themselves growing from the system. The pots would be arranged in a circle around the centrally placed pump, ensuring equal spreading of nutrients/water.

### 7.2.2. Grow bed pots (Figure 24)

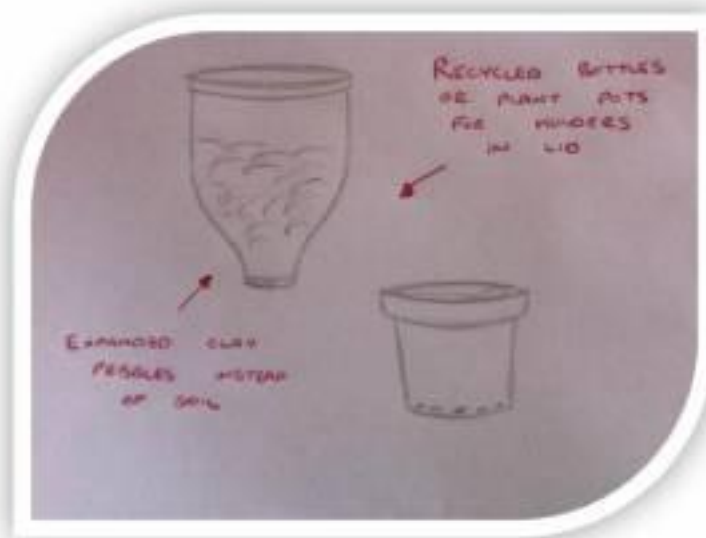

Figure 24: Grow bed pots drawing

The pots used to hold the media and plants was initially thought to be a reused product such as glass or plastic bottles that have been cut down to correct size. These bottles could of added an aesthetic look to the top of the bed. A rubber coating was to be added to the cut edges of the bottles to ensure safety while handling. We found this to be an interesting style and possible simple solution.

Simple plant pots then became the main focus of our idea. As the design itself developed so did the idea of using bottles as pots. The process of just reusing plastic plant

pots instead of cutting your own with the rubber dipped edges was a lot smarter and simpler. It also allowed the plant pots to be reused before being recycled. Glass bottles with a rubber element would have been much harder to recycle and this idea was taken out.

The Plant pots will follow the shape of the Grow Bed as to fit tight to one another in order to create a garden/lawn effect.

### 7.2.3. Development

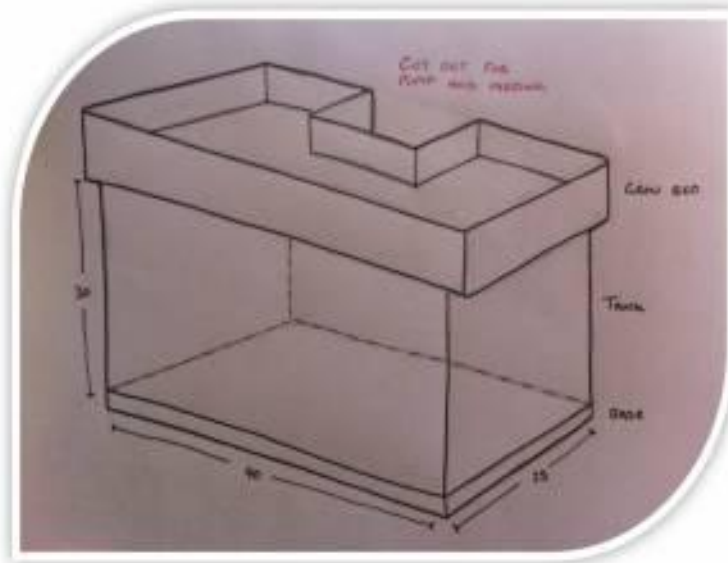

Figure 25: Our main design drawing

The Development of our main idea (Figure 25) came quickly through the research stage of our project. We found that it was unethical to use a cylindrical tank for fish and although there are many on the market we decided it was better to think about the fish's well-being and cause as little stress as possible. We decided upon a cuboid as our tank body as this is the most commonly used on the market today and other options would be too hard to create.

Through development we found that the cuboid tank would offer more water due to its corners whereas the cylinder did not have these. This also improved the well-being of any fish kept within the tank as fish prefer a large body of water to swim freely. It also meant that we could possibly add an extra fish to the tank as we are less limited with space.

The change of shape provided a stronger base for the tank but produced weak spots at the corners. This would be tackled by metal supports hidden behind the veneer/plastic strips that would wrap around the base and top just as in the cylindrical design. The design is almost the exact duplicate bar the main body shape change.

The design would still incorporate the LED strips around the under side of the grow bed for aesthetic appeal.

The grow bed design now follows the shape of the cuboid tank apart from an area taken out the back middle section. This was to allow the pump to sit in the middle of the tank and to allow feeding of the fish with ease. This area will often be covered from view by the plants growing within the grow bed and does not take anything away from the physical appearance of the tank itself.

The debate of using a stand pipe, syphon or simple drainage system and how to ensure even flow of water throughout grow bed are the two main debates with the design.

#### 7.2.4. CAD/Modelling Development

As we began to model the system in both CAD and cardboard we found that there were many areas that needed addressing.

##### 7.2.4.1. Bell Siphon Development

After modelling the Bell Siphon seen in Figure 26 we were able to understand clearly how it worked by using the section view (Figure 27) to plan the path of the water (Figure 28). After discussions as a group and with supervisors we found that a more simple method would work just as effectively. This method simply involved a tube with a much smaller diameter than the pump tube so that the grow bed could fill with water as the smaller tube could not expel the rising water as quickly as it was being pumped into the grow bed. This small tube would be surrounded by a similar guard/filter to the one in the Bell Siphon to stop any waste/dirt. The developed system can be seen in Figure 29.



Figure 26: Bell siphon

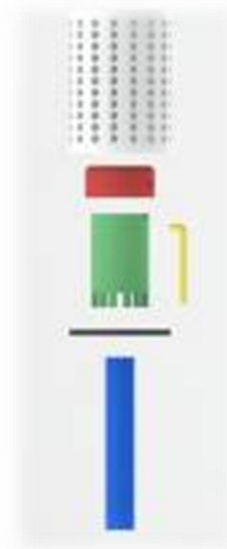

Figure 27: Bell siphon exploded view

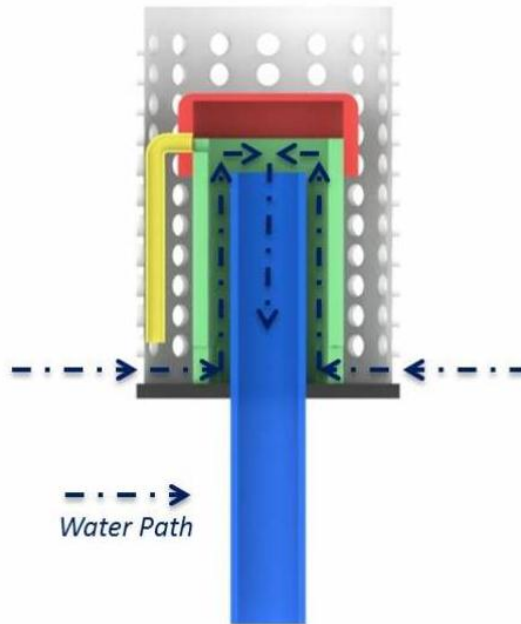

Figure 28: Bell siphon water path

#### 7.2.4.2. Fail Safe Development

Originally we planned and designed to have small cut outs where the pipe entered the grow bed as fail safes in-case the bell siphon/stand pipe failed. We found that these cut outs would not direct the water directly back to the tank and this could lead to splashes over the side of the tank. The development of this was to use a single pipe at a preset safety level. The pipe itself would be larger than the pump pipe so that it could remove the water quicker than it was coming in to the grow bed so that it would not spill over the side or reach the height of the electronics casing. The fail safe stand pipe can be seen in Figure 29 and clearly shows its large size to easily remove the water.

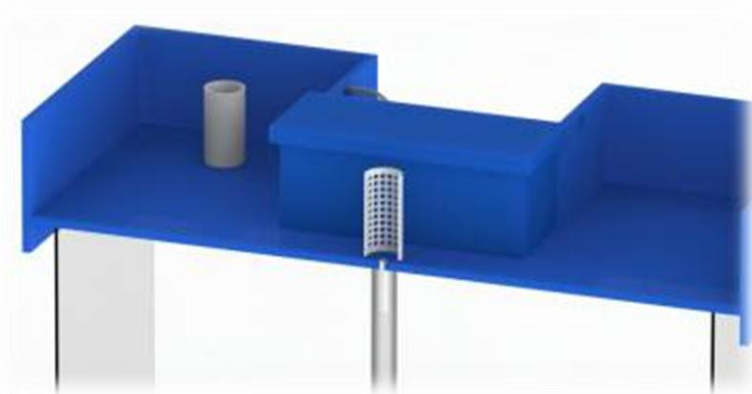

Figure 29: Fail safe stand pipe

### 7.2.4.3. Grow Bed

The Grow Bed (Figure 30) itself was developed a large amount during the development phase to fit with the changing electronic and design demands.

- Cut outs were added to the bed to allow the pump tubing to go straight into the bed instead of sitting atop a side (Figure 31+32).
- The sides of the bed were increased by 10mm to allow extra space for water.
- Holes were added for the stand pipes.
- Stabilising features were added to keep the bed in place. (Figure 31 and Figure 32).

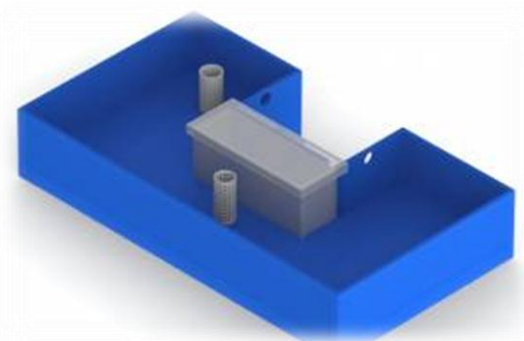

Figure 30: Grow bed design

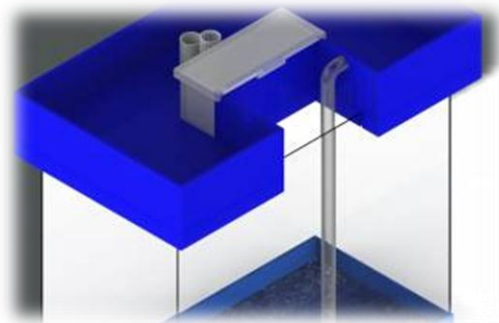

Figure 31: Pipe from water pump view

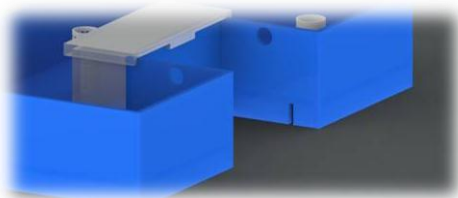

Figure 32: Grow bed stabilising view



Figure 33: Grow bed section view for stabilising features

### 7.2.4.4. Electronic Housing

The placement of the electronics was an area which required a large amount of time due to the safety risk between electronics and water.

Initially we wanted to place the electronics outside and on the back of the tank however there were several problems with this including bulky housing, lack of stability on back of tank and an unattractive design solution. In the end we decided to create a small space within the Grow Bed for the electronics as shown in Figure 34. This small area would come with a lid for easy removal of the electronics while also keeping them safe from water

splashes (Figure 35). Also the housing would include a small cut out from the back where the wires could pass through so that the lid could stay secure (Figure 34).

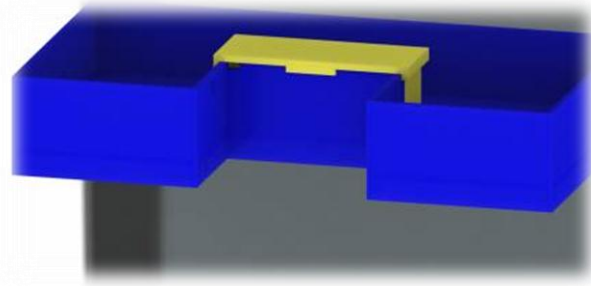

Figure 34: Grow bed back view

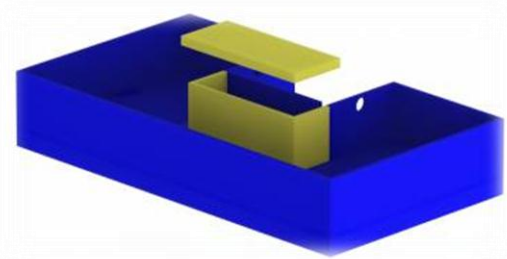

Figure 35: Grow bed view for electronics

#### 7.2.4.5. Final Design Development

The Figure 36 shows our final design including all new developments. The fail safe pipe was moved so that less space was taken from the plants and is now next to the stand pipe. This also means that all water is coming down in the same area so not to overly disturb the fish.

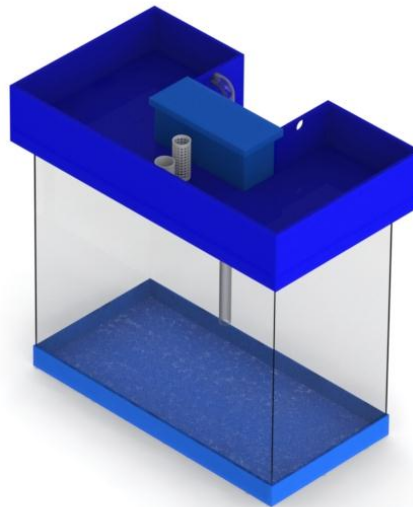

Figure 36: Final aquaponics system design

Figure 37 shows the final cutting list for the grow bed. This was to be used to help cut and construct the final build.

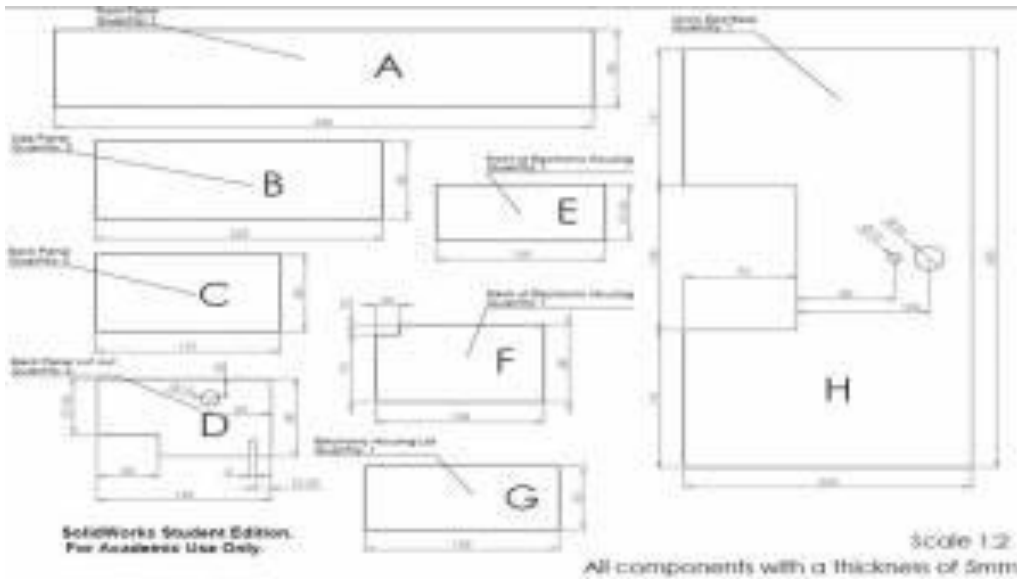

Figure 37: Final cutting list for the grow bed

### 7.3. Components

If we want to be successfully with the aquaponic system we have to check the water temperature and pH. Therefore, we will need an electronic system. It will be composed with the following components:

#### 7.3.1. Motherboard

The motherboard will be the Arduino Duemilanove because we can program the microcontroller with the free Arduino software. The board can operate on 5V.

Table 7: Specifications of Arduino board Duemilanove [32]

Summary	
<b>Microcontroller</b>	ATmega168
<b>Operating Voltage</b>	5V
<b>Input Voltage (recommended)</b>	7-12V
<b>Input Voltage (limits)</b>	6-20V
<b>Digital I/O Pins</b>	14 (of which 6 provide PWM output)
<b>Analog Input Pins</b>	6
<b>DC Current per I/O Pin</b>	40 mA
<b>DC Current for 3.3V Pin</b>	50 mA
<b>Flash Memory</b>	16 KB (ATmega168) or 32 KB (ATmega328) of which 2 KB used by bootloader
<b>SRAM</b>	1 KB (ATmega168) or 2 KB (ATmega328)
<b>EEPROM</b>	512 bytes (ATmega168) or 1 KB (ATmega328)
<b>Clock Speed</b>	16 MHz



Figure 38: Arduino Duemilanove model: ARDU-0004 [33]

Furthermore, it has 14 digital pins that can be used as an input or output and they operate at 5V. Also, Duemilanove has 6 analog inputs. Additionally some of the digital and analog pins have speciality functionality.

### 7.3.2. LCD screen

A basic green LCD screen is the best option for our prototype because it is easy to use with Arduino and has a cheap price. It will be connected to the power supply (5V) and to Arduino.

Table 8: Specification of LCD 16x2 black and green [34]

Summary	
Minimum logic voltage	4.5 V
Maximum logic voltage	5.5 V
Supply current	120 mA
Text	Black on Green background

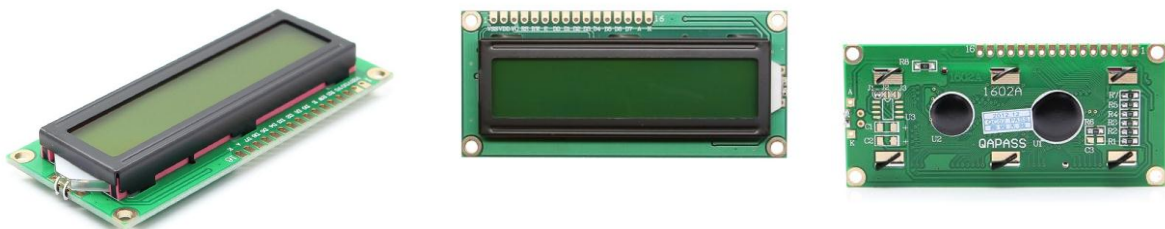

Figure 39: LCD module 16x2 black and green [35]



### 7.3.3. Temperature sensor

Temperature Sensor with the reference DS18B20 is the best option because it is waterproof and the temperature range that it checks is far enough. The sensor will be powered by data line to the Phidget Interface Kit 8/8/8 Model: PHD-1018\_2.

Table 9: Specification of temperature sensor waterproof DS18B20 [36]

Summary	
Input voltage	3.0-5.5V
Temperature range	-55°C to+125°C
±0.5°C accuracy from	-10°C to +85°C
Characteristic	Waterproof
Wire interface	1

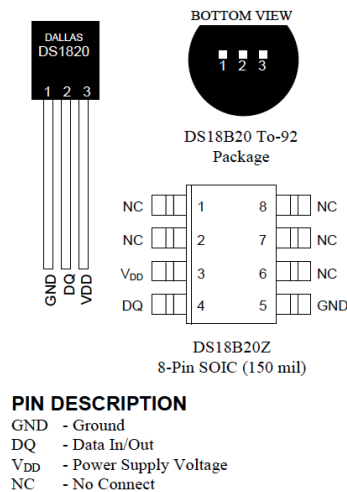

Figure 40: Pin assignment of the temperature sensor [36]



Figure 41: Temperature Sensor - Waterproof (DS18B20) [37]

### 7.3.4. Control sensor interface

The control sensors interface will be used thinking about the future of the project and the measurements stability. Phidget will let us connect more sensors. It is used to measure continuous quantities. Furthermore, it provides 8 analog and 8 digital inputs. We will connect to the interface the temperature and the pH sensor. After the Phidget will be plug to Arduino.

Table 10: Specification of phidget interface PHP-1018\_2 [38]

Summary	
USB Voltage	4.6 V DC- 5.5 V DC
Current Consumption	13mA-500mA
Available External Current	487 mA
Recommended Wire Size	16 - 26 AWG
USB Speed	Full Speed
Operating Temperature	0°C - 70°C
Analog inputs	8 with configurable data acquisition rates
Digital inputs	8 with hardware noise filtering
<b>5V terminal block besides Analog Input 7 and Digital Output 7</b>	



Figure 42: Phidget Interface Kit 8/8/8 Model: PHD-1018\_2 [39]

### 7.3.5. pH sensor

The ASP2000 pH sensor is good for our project because it measures acidity from 0 to 14. Additionally it is economic and resistant due to the epoxy body.

Table 11: Specification of pH/ORP sensor [40]

Summary	
<b>No need to refill the KCL solution</b>	
pH range	0-14
Operating Temperature	0-80°C
Electrode Response Time Max	10s
Electrode Type	Combination Single-Junction
Exterior Tube Material	Impact Resistant Plastic
Connector Type	BNC
Length	120mm
Diameter	12mm
Cable Length	1 m



Figure 43: ASP200-2-&M-BNC pH Lab Electrode [41]

### 7.3.6. pH/ORP adapter

The pH/ORP adapter is necessary to feeds the data to an analog input on a PhidgetInterface board. This adapter connects to an Analog Input PhidgetInterface that comes packaged with: 3002 - 60cm sensor cable.

Table 12: Specifications of pH/ORP adapter [42]

Summary	
<b>Current Consumption</b>	3.0 mA
<b>Input Voltage</b>	4.5 VDC to 5.25 VDC
<b>Min/Max Error</b>	±0.09 pH
<b>Typical Error</b>	±0.02 pH



Figure 44: pH/ORP Adapter Model: PHD-1130 [43]



Figure 45: 3002 - 60cm Sensor Cable [44]



Figure 46: pH sensor + pH/ORP Adapter + PhidgetInterface [45]

### 7.3.7. Relay

To connect and disconnect the pump we need a relay that works like a switch.

Table 13: Specifications of relay 1872939 [46]

Summary	
<b>Contact Current</b>	10A
<b>Contact Voltage VAC</b>	250V
<b>Coil Current</b>	72mA
<b>Coil Type</b>	DC
<b>Coil Voltage VDC Nom</b>	5V
<b>Operating Temperature</b>	-40°C to 85°C
<b>Relay Type</b>	Miniature

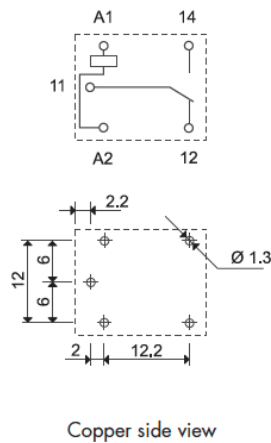

Figure 47: Schematic of the relay [46]



Figure 48: Our relay

### 7.3.8. Current driver

The electronic part works in alternating current (AC) and the pump in direct current (DC) due that we need a current driver to change from DC to AC.

Table 14: Specifications of ULN2003 current driver [47]

Summary	
<b>Collector-Emitter Voltage</b>	50V
<b>Input Voltage</b>	30A
<b>Peak collector Current</b>	500mA
<b>Total Emitter-Terminal</b>	500mA
<b>Power disipation</b>	500mW $T_{amb}=25^{\circ}C$ 495mW $T_{amb}<85^{\circ}C$
<b>Operating Temperature</b>	-20 °C +85 °C
<b>Relay driver application</b>	
<b>Inputs compatible with various types of logic.</b>	



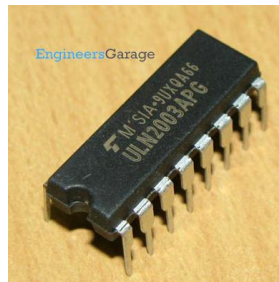

Figure 49: Current driver ULN2003 [48]

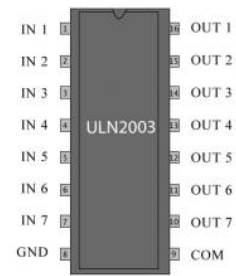

Figure 50: Pin diagram of current driver [47]

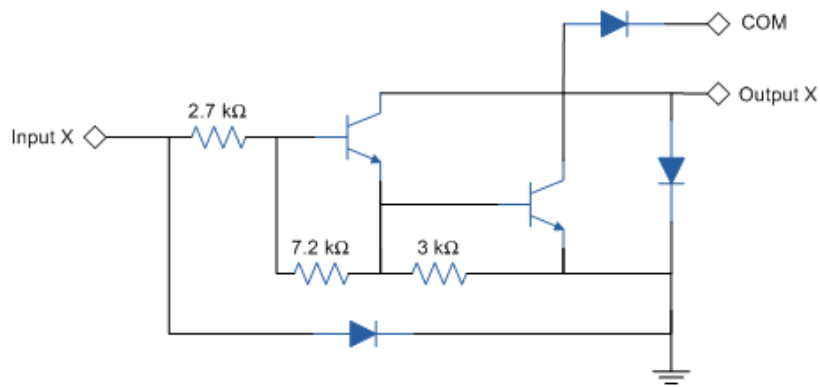

Figure 51: Schematic (each darlington pair) [47]

### 7.3.9. Power supply

The components works with 5V then we need a 5V power supply. We choose the model INM-0761 because it has 2.5A that is enough for our project.

Table 15: Specifications of the power supply 5V 2.5A with DC plug [49]

Summary	
Output Connector	DC Male Plug
Input Voltage	90 to 264V ac
Output Current	2.5A
Output Voltage	5V dc
Plug Type	Euro
Power Rating	12.5W
Efficiency	79.15%
Type	Switch Mode
Weight	110g
Dimensions (L x W x H):	69.3 mm x 41.4 mm x 65 mm





Figure 52: Power supply 5V, 2.5A, model: INM-0761 [50]

#### 7.4. Functionalities

Our Aquaponic system will work via the following steps:

1. The water of the fish tank is flowing in the grow bed by the water pump, it's a flood and drain system (1). The water is controlled by the Arduino, manipulated by the Relay and programmed to be switch ON and switch OFF.
2. When the water is flowing up in the grow bed on a specific level, the water pump is turned OFF. At the moment, the water can provide all plants and clay pebbles in excrement. Then, the water will go back to the fish tank by a small pipe.
3. Sensors within the tank send information to the Arduino which is then relayed onto the LCD screen.

If for an unknown reason the water pump is kept running and the stand pipe cannot handle the flow then the water will rise to a set level where we have installed a fail-safe stand pipe so the water will quickly drain back to the fish tank. This larger pipe is included so the water does not overflow out of the grow bed.

In the following electronic drawing (Figure 53), you can see the main electronic components, how they will be set up and how they will connect with each other.

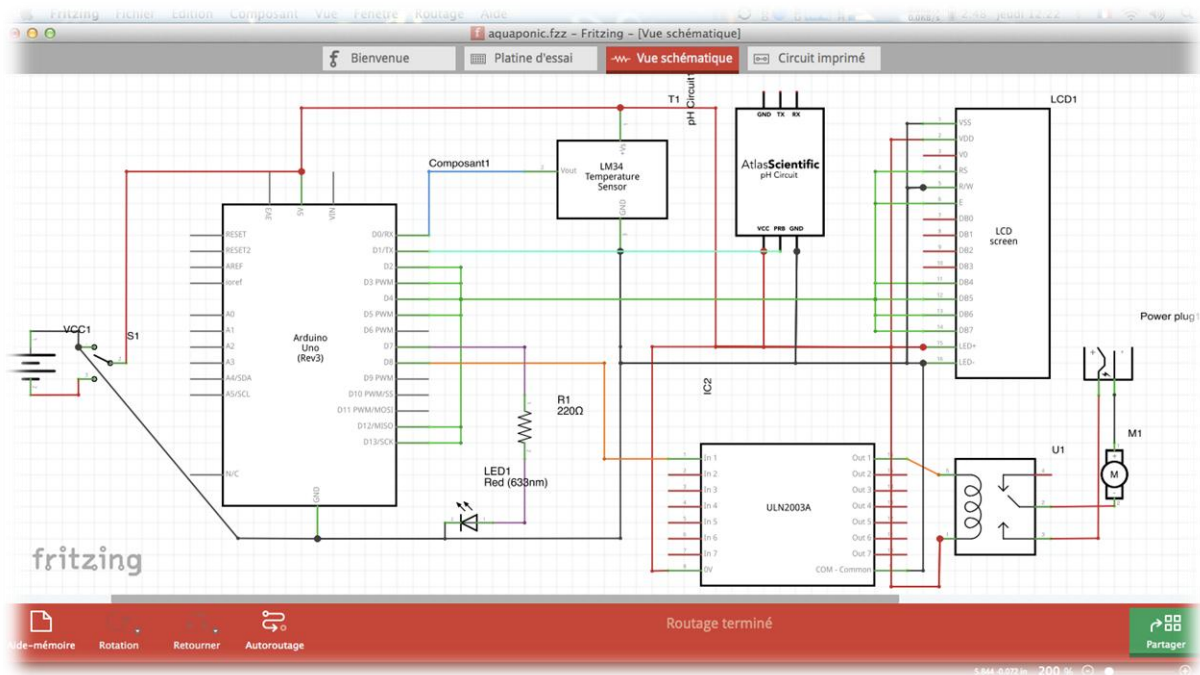

Figure 53: Components electronic drawing

### 7.5. Tests and Results

All of these functionalities described in the previous section need to be tested before we put it into the final setup. Our supervisors told us to test how well the current driver and the relay function.

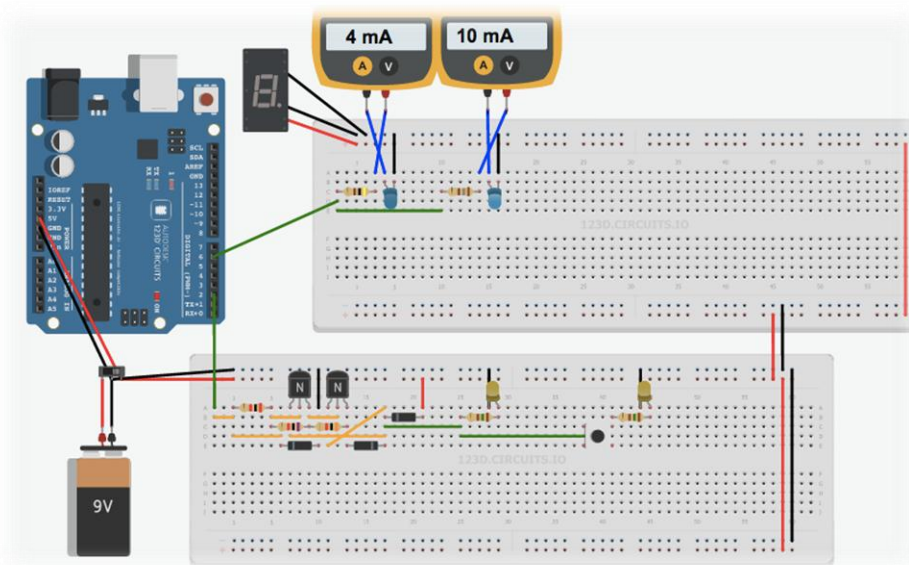

Figure 54: Simulation drawing

**7.5.1. Current driver simulation**

In black on the Figure 55, there is the current driver. After initializing the Arduino motherboard and connecting onto the digital PIN 2, the first yellow LED circled in red in the Figure 55 turns ON. This means that the current driver works.

**7.5.2. Relay simulation**

In purple on the Figure 55, there is the relay. After initializing the Arduino motherboard and connecting onto the digital PIN 2, the first yellow LED circled in red turns on and the second yellow LED circled in blue turns on as well. The relay works correctly as a switch because we can see with a set code through the Arduino that the LED's turn on and off at set times.

**7.5.3. Sensor simulation**

Our temperature sensor reacts to changes in temperature by changing resistance. For this test, we used two different resistances to illustrate two different temperatures (Figure 55). On the multimeter we can see 4mA and 10mA, this is the current after each resistances, this means we just need to send these signals to the Arduino to show them as temperatures on the LCD screen.

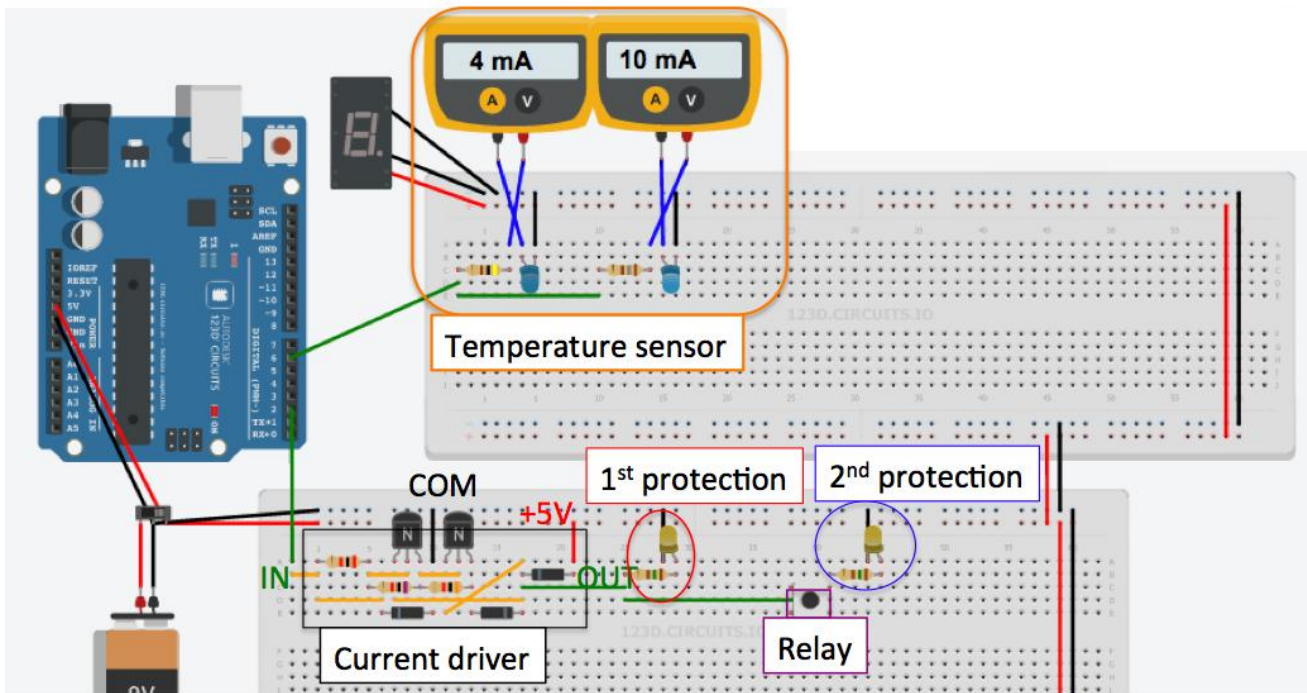

Figure 55: Simulation drawing with descriptions



## 7.6. Conclusion

The chapter as a whole describes the process of designing, testing, developing and finalising a product.

After moving swiftly through the design stages and using all aspects (ethics, marketing, etc) to create a quality design we found that a simple product that fit our needs was possible. However the technology/electronics that would be incorporated in the system also affected the final design due to restraints regarding size and placement of certain components. Taking this into account we developed an attractive system that combines art and technology together.

Through development we were pushed to change many features of the design and many of these simplified the final product and led to an overall cheaper and easy to manufacture prototype.

Overall we found that from the start of the brainstorming to the final renders, our ideas of a successful and quality aquaponics system had changed vastly. This knowledge was gained mostly through research and we believe that this led to the creation of a desirable and functioning system that fits well into the intended markets.



# Chapter 8

---

## 8. Conclusions

### 8.1. Discussion

Our main objective was to create a working system that supported both fish and plant cultures and through long research and development phases we believe that we have created a system that can complete the required objective and be aesthetically pleasing. Due to the electronics put in place within our system and the necessary tests conducted, we are able to monitor the system and ensure optimum conditions at all times. In order to be sustainable we believed the project should run at 15-30 minute intervals. This would save power compared to a continuous system and provides plants extra oxygen in order for quicker growth.

Overall in our own opinions we have completed the requirements and also expanded so that the system will be successful within the intended target market due to an aesthetic design and simple functionality.

### 8.2. Future development

Regarding future development we would possibly look towards creating a much cheaper product that can be made from entirely recycled materials to be shipped/manufactured within third world countries. The benefits of an Aquaponics system within these countries would be immediately felt due to the increase in both food and water resources.



# References

---

- [1] Obash Rune. (2006, November) Wikipedia. [Online].  
<http://fr.wikipedia.org/wiki/Aquaponie>
- [2] Franck Emmans. (2013, december) Network survivaliste francophone. [Online].  
<http://www.network-survivaliste-francophone.com/nourriture-autonomie-independance-survivalisme/aquaponie/laquaponie-quest-ce-que-cest/>
- [3] Figure 1: the nitrogen cycle in an aquaponics system ,  
[http://api.ning.com/files/BykvwnNi9Lu4BORU5fhehC2ljkTW1GQ6PFXrbKQn3r0UYPbaNo5NJ\\*oXMcfyBRckj8L8-F6J-McB8fnUHEeFP70NhtfBwTfO/nitro.jpg](http://api.ning.com/files/BykvwnNi9Lu4BORU5fhehC2ljkTW1GQ6PFXrbKQn3r0UYPbaNo5NJ*oXMcfyBRckj8L8-F6J-McB8fnUHEeFP70NhtfBwTfO/nitro.jpg)
- [4] Figure 2: Simple functioning example of an Aquaponics system,  
<http://diyaquaponicsguide.com/wp-content/uploads/2013/08/DIY-Aquaponics.jpg>.
- [5] Figure 3: Example of a NFT culture system, <http://www.superaktif.net/wp-content/upLoads/2011/12/nft1.jpg>.
- [6] Figure 4: Example of an DWC system,  
<http://theolleys.files.wordpress.com/2012/05/dwc-raft.jpg?w=820>.
- [8] Figure 6: Example of continuous flow circulation, <http://aquaponie-pratique.com/wp-content/uploads/2014/02/systeme-aquaponie-sans-siphon.jpg>.
- [7] Figure 5: Example of a media filled bed culture system, <http://aquaponicswork.com/wp-content/uploads/2014/04/back-yard-aquaponics-3.jpg>.
- [9] Figure 7: Example of a flood and drain circulation,  
<https://www.youtube.com/watch?v=ZHaiVhVZ3kM>.
- [10] Figure 8: Example of Chist pist circulation, <http://www.network-survivaliste-francophone.com/wp-content/uploads/2013/12/aquaponie-chop.jpg>.
- [11] Figure 10: PEST analysis diagram, <http://www.marketingteacher.com/pest-analysis>.
- [12] (2014) Wikipedia. [Online]. [http://en.wikipedia.org/wiki/Organic\\_food](http://en.wikipedia.org/wiki/Organic_food)
- [13] Figure 11: Organic food sales, <http://naturalresourcereport.com/2009/09/chart-organic-growth-by-food-group/>.
- [14] Brandt Michelle. (2012) Little evidence of health benefits from organic foods, Stanford study finds. [Online]. <http://med.stanford.edu/ism/2012/september/organic.html>
- [15] (2014) Back to the Roots. [Online]. [www.backtotheroots.com](http://www.backtotheroots.com)
- [16] Figure 12: Back to the Roots' aquaponics system, <http://www.theshelbyreport.com/wp-content/uploads/2013/04/Back-to-the-Roots-Aquaponic-garden-WEB.jpg>.
- [18] Figure 13: Acquaponics system by Backyard Aquaponics, [www.backyardaquaponics.com](http://www.backyardaquaponics.com).
- [17] Backyard Aquaponics. (2012) Backyard Aquaponics. [Online].  
[www.backyardaquaponics.com](http://www.backyardaquaponics.com)
- [19] Nelson, Pade, and Inc. (2013) Nelson and Pade Shop. [Online].  
[store.aquaponics.com/index.php?route=common/home](http://store.aquaponics.com/index.php?route=common/home)
- [20] Figure 14: Aquaponics system by Nelson Pade's Shop,  
[store.aquaponics.com/index.php?route=common/home](http://store.aquaponics.com/index.php?route=common/home).



- [21] Figure 15: Targeting subsets of consumers, [cwcc.wordpress.com/2011/02/07/tips-for-defining-your-target-market](http://cwcc.wordpress.com/2011/02/07/tips-for-defining-your-target-market).
- [22] Jack Trout. (2009) Brand positioning basics. [Online].  
[www.brandingstrategyinsider.com/2009/02/brand-positioning-basics.html#.U5Hn\\_N4SOYA](http://www.brandingstrategyinsider.com/2009/02/brand-positioning-basics.html#.U5Hn_N4SOYA)
- [23] Jack Trout. (2014) Summary of positioning. Abstract. [Online].  
[www.valuebasedmanagement.net/methods\\_trout\\_positioning.html](http://www.valuebasedmanagement.net/methods_trout_positioning.html)
- [24] Figure 16: Maslow's hierarchy of needs diagram, [en.wikipedia.org/wiki/Abraham\\_Maslow](http://en.wikipedia.org/wiki/Abraham_Maslow).
- [25] Figure 17: Aps marketing mix example, [www.smartdraw.com/examples/view/4ps+marketing+mix/](http://www.smartdraw.com/examples/view/4ps+marketing+mix/).
- [26] The Chartered Institute of Marketing. (2014) An overview of marketing. [Online].  
[www.cim.co.uk/marketingplanningtool/intro.asp](http://www.cim.co.uk/marketingplanningtool/intro.asp)
- [28] The Royal Academy of Engineering. (2011, August) Raeng. [Online].  
[http://raeng.org.uk/societygov/engineeringethics/pdf/Engineering\\_ethics\\_in\\_practice\\_short.pdf](http://raeng.org.uk/societygov/engineeringethics/pdf/Engineering_ethics_in_practice_short.pdf)
- [27] Figure 19: Three spheres of sustainability diagram, [cft.vanderbilt.edu/files/ven-sus.png](http://cft.vanderbilt.edu/files/ven-sus.png).
- [29] National Society of Professional Engineers. (2007, July) NSPE. [Online].  
<http://www.nspe.org/sites/default/files/resources/pdfs/Ethics/CodeofEthics/Code-2007-July.pdf>
- [30] Inc. and the Institute for Electrical and Electronics Engineers, Inc. Association for Computing Machinery. (1999) Association for Computing Machinery. [Online].  
<http://www.acm.org/about/se-code>
- [31] Snejanka Penkova. (2013, September) Centro Para la Excelencia Académica. Universidad de Puerto Rico recinto de Río Piedras. [Online]. <http://cea.uprrp.edu/wp-content/uploads/2013/10/Dra.-Snejanka-Penkova.-Etica-de-investigacion-27.09.13.pdf>
- [32] Arduino. (2009) Board Duemilanove. [Online].  
<http://arduino.cc/en/Main/arduinoBoardDuemilanove>
- [33] Figure 38: Arduino duemilanove model: ARDU-004, [www.inmotion.pt/store/arduino-duemilanove](http://www.inmotion.pt/store/arduino-duemilanove).
- [34] Inmotion. (2013, November) [Online]. <http://www.inmotion.pt/store/lcd-module-16x2-black-on-green>
- [35] Figure 39: LCD module 16x2 black and green, [www.inmotion.pt/store/lcd-module-16x2-black-on-green](http://www.inmotion.pt/store/lcd-module-16x2-black-on-green).
- [36] Dallas Semiconductor. (2012, July) Inmotion. [Online].  
<http://inmotion.pt/documentation/sparkfun/SEN-11050/DS18B20.pdf>
- [38] Phidgets. (2014, April) [Online]. [http://www.phidgets.com/docs/1018\\_User\\_Guide](http://www.phidgets.com/docs/1018_User_Guide)
- [37] Figure 41: Temperature sensor - waterproof (DS18B20), [www.inmotion.pt/store/temperature-sensor-waterproof-ds18b20](http://www.inmotion.pt/store/temperature-sensor-waterproof-ds18b20).
- [39] Figure 42: Phidget interface kit 8/8/8 model: PHP 1018\_2, [www.inmotion.pt/store/phidgetinterfacekit-888](http://www.inmotion.pt/store/phidgetinterfacekit-888).
- [40] Phidgets. (2013, October) [Online].  
[http://www.phidgets.com/docs/PH/ORP\\_Sensor\\_Primer](http://www.phidgets.com/docs/PH/ORP_Sensor_Primer)



- [41] Figure 43: ASP200-2-&M-BNC pH Lab Electrode, [www.inmotion.pt/store/asp200-2-1m-bnc-ph-lab-electrode](http://www.inmotion.pt/store/asp200-2-1m-bnc-ph-lab-electrode).
- [42] Phidgets. (2009) Inmotion. [Online]. <http://www.inmotion.pt/store/phorp-adapter>
- [43] Figure 44: Ph/ORP adapter model: PHP-1130, [www.inmotion.pt/store/phorp-adapter](http://www.inmotion.pt/store/phorp-adapter).
- [44] Figure 45: 3002-60cm sensor cable, [www.inmotion.pt/store/sensor-cable-60-cm](http://www.inmotion.pt/store/sensor-cable-60-cm).
- [45] Figure 46: pH sensor + pH/ORP adapter + phidget interface, [www.phidgets.com/products.php?product\\_id=3550](http://www.phidgets.com/products.php?product_id=3550).
- [46] Finder. Farnell element 14. [Online]. <http://www.farnell.com/datasheets/1504641.pdf>
- [48] Figure 49: Current driver ULN2003, [www.engineersgarage.com/sites/default/files/ULN2003.JPG?1301041023](http://www.engineersgarage.com/sites/default/files/ULN2003.JPG?1301041023).
- [47] Engineers garage. (2012) [Online]. <http://www.engineersgarage.com/sites/default/files/ULN2003.pdf>
- [49] Inmotion. (2013, November) [Online]. <http://www.inmotion.pt/store/power-supply-5v-2-5a-eu-with-dc-plug>
- [50] Figure 52: Power supply 5V, 2.5A, model: INM-0761, [www.inmotion.pt/store/power-supply-5v-2-5a-eu-with-dc-plug](http://www.inmotion.pt/store/power-supply-5v-2-5a-eu-with-dc-plug).
- [51] JR. Charles Edwin Harris, Michael Davis, Michael S.Pritchard, and Michael J.Rabins, "Engineering Ethics: What? Why? How? and When?," *The Research Journal for Engineering Education*, vol. 85, no. 2, pp. 93-96, April 1996. [Online]. <http://onlinelibrary.wiley.com/doi/10.1002/j.2168-9830.1996.tb00216.x/abstract>
- [52] François De Grave and Eric Barzin. (2013) l'aquaponie pratique pour le développement de l'aquaponie. [Online]. <http://aquaponie-pratique.com/aquaponie-c-est-quoi>
- [53] Greg. (2013, November) aquaponie.net. [Online]. <http://aquaponie.net/le-design-general-du-systeme/>
- [54] Gilberto. (2014, January) hydroponie.fr. [Online]. <http://hydroponie.fr/category/substrat/>
- [55] Emmans Franck. (2014, January) network-survivaliste-francophone.com. [Online]. <http://www.network-survivaliste-francophone.com/nourriture-autonomie-independance-survivalisme/aquaponie/les-legumes-en-aquaponie/>
- [56] Emmans Franck. (2014, January) network-survivaliste-francophone.com. [Online]. <http://www.network-survivaliste-francophone.com/nourriture-autonomie-independance-survivalisme/aquaponie/les-poissons-pour-laquaponie/>
- [58] (2012) backyardaquaponics.com. [Online]. <http://www.backyardaquaponics.com/guide-to-aquaponics/running-of-the-system/>
- [57] Eric. (2014, February) aquaponie-pratique.com. [Online]. <http://aquaponie-pratique.com/demarrer-un-systeme-d-aquaponie>
- [59] Sylvia. (2011, February) theaquaponicsource. [Online]. <http://theaquaponicsource.com/2011/02/07/starting-up-cycling-an-aquaponics-system-using-fish/>
- [60] Backyard Aquaponics. (2012) Backyard Aquaponics. [Online]. [www.backyardaquaponics.com](http://www.backyardaquaponics.com)
- [61] Nelson, Pade, and Inc. (2013) Nelson Pade Shop. [Online]. [store.aquaponics.com/index.php?route=common/home](http://store.aquaponics.com/index.php?route=common/home)



- [62] Figure 15: Targeting subsets of consumers,  
<https://cwcc.wordpress.com/2011/02/07/tips-for-defining-your-target-market>.
- [63] Jack Trout. (2009) Brand positioning basics. [Online].  
[www.brandingstrategyinsider.com/2009/02/brand-positioning-basics.html#.U5Hn\\_N4SOYA](http://www.brandingstrategyinsider.com/2009/02/brand-positioning-basics.html#.U5Hn_N4SOYA)
- [64] Jack Trout. (2014) Summary of positioning. [Online].  
[http://www.valuebasedmanagement.net/methods\\_trout\\_positioning.html](http://www.valuebasedmanagement.net/methods_trout_positioning.html)
- [65] Figure 16: Maslow's hierarchy of needs, en.wikipedia.org/wiki/Abraham\_Maslow.
- [66] Figure 17: 4ps marketing mix example,  
[www.smartdraw.com/examples/view/4ps+marketing+mix/](http://www.smartdraw.com/examples/view/4ps+marketing+mix/).
- [67] The Chartered Institute of Marketing. (2014) An overview of marketing. [Online].  
[www.cim.co.uk/marketingplanningtool/intro.asp](http://www.cim.co.uk/marketingplanningtool/intro.asp)



# List of tables

---

Table 1: Team members.....	6
Table 2: Task attribution .....	8
Table 3: Work's distribution .....	26
Table 4: Risks and solutions .....	27
Table 5: Stakeholders' expectations .....	28
Table 6: SWOT analysis description .....	34
Table 7: Specifications od Arduino board Duemilanove [32] .....	63
Table 8: Specification of LCD 16x2 black and green [34] .....	64
Table 9: Specification of temperature sensor waterproof DS18B20 [36] .....	65
Table 10: Specification of phidget interface PHP-1018_2 [38].....	66
Table 11: Specification of pH/ORP sensor [40] .....	66
Table 12: Specifications of pH/ORP adapter [42] .....	67
Table 13: Specificatios of relay 1872939 [46] .....	68
Table 14: Specifications of ULN2003 current driver [47].....	68
Table 15: Specifications of the power supply 5V 2.5A with DC plug [49].....	69



# List of figures

Figure 1: The nitrogen cycle in an aquaponics system [3] .....	10
Figure 2: Simple functioning example of an aquaponics system [4] .....	11
Figure 3: Example of a NFT culture system [5] .....	14
Figure 4: Example of an DWC system [6] .....	15
Figure 5: Example of a media filled bed culture system [7].....	15
Figure 6: Example of continous flow circulation [8] .....	16
Figure 7: Example of flood and drain circulation [9].....	17
Figure 8: Example of Chift pist circulation [10].....	18
Figure 9: Team 5 Gantt Chart .....	25
Figure 10: PEST analysis diagram [11].....	30
Figure 11: Organic food sales [13] .....	31
Figure 12: Back to the Roots' aquaponics system [16] .....	33
Figure 13: Aquaponics system by Backyard Aquaponics [18].....	33
Figure 14: Aquaponics system by Nelson Pade's Shop [20].....	34
Figure 15: Targeting subsets of consumers [21] .....	35
Figure 16: Maslow's hierarchy of needs diagram [24].....	37
Figure 17: 4ps marketing mix example [25].....	39
Figure 18: Our logo .....	40
Figure 19: Three spheres of sustainability diagram [27].....	44
Figure 20: Duties diagramm .....	49
Figure 21: Our logo .....	53
Figure 22: Values diagramm.....	53
Figure 23: Our initial design .....	56
Figure 24: Grow bed pots drawing .....	57
Figure 25: Our main design drawing .....	58
Figure 26: Bell siphon .....	59
Figure 27: Bell siphon exploded view.....	59
Figure 28: Bell siphon water path .....	60
Figure 29: Fail safe stand pipe.....	60
Figure 30: Grow bed design .....	61
Figure 31: Pipe from water pump view.....	61
Figure 32: Grow bed stabilising view .....	61
Figure 33: Grow bed section view for stabilising features.....	61
Figure 34: Grow bed back view .....	62
Figure 35: Grow bed view for electronics .....	62
Figure 36: Final aquaponics system design.....	62
Figure 37: Final cutting list for the grow bed .....	63
Figure 38: Arduino Duemilanove model: ARDU-0004 [33].....	64
Figure 39: LCD module 16x2 black and green [35] .....	64
Figure 40: Pin assignment of the temperature sensor [36].....	65
Figure 41: Temperature Sensor - Waterproof (DS18B20) [37].....	65
Figure 42: Phidget Interface Kit 8/8/8 Model: PHD-1018_2 [39] .....	66
Figure 43: ASP200-2-&M-BNC pH Lab Electrode [41].....	67
Figure 44: pH/ORP Adapter Model: PHD-1130 [43] .....	67





Figure 45: 3002 - 60cm Sensor Cable [44] .....	67
Figure 46: pH sensor + pH/ORP Adapter + PhidgetInterface [45] .....	67
Figure 47: Schematic of the relay [46] .....	68
Figure 48: Our relay.....	68
Figure 49: Current driver ULN2003 [48] .....	69
Figure 50: Pin diagram of current driver [47] .....	69
Figure 51: Schematic (each darlington pair) [47].....	69
Figure 52: Power supply 5V, 2.5A, model: INM-0761 [50] .....	70
Figure 53: Components electronic drawing .....	71
Figure 54: Simulation drawing .....	71
Figure 55: Simulation drawing with descriptions.....	72



# Glossary

<b>Ammonia</b>	Produced by the fish in their waste and through the gills, can build up becoming toxic if not diluted or converted in the system.
<b>Aquaculture</b>	The cultivation of aquatic animals and plants in a controlled environment.
<b>Aquaponics</b>	Symbiotic relationship of plants and fish growing together in a system.
<b>Autosiphon</b>	Useful mechanism for controlling flood and drain cycles of a grow bed
<b>Bacillus thuringensis</b>	Naturally occurring micro-organism effective as a treatment against caterpillars. Certified organic and not harmful to beneficial organisms
<b>Bacteria</b>	Naturally occurring microscopic organisms, both good and bad
<b>Biological filter</b>	Place that supports the colonisation of nitrifying bacteria, eg. growbed
<b>BYAP</b>	Backyard Aquaponics
<b>CHIFT PIST</b>	Constant height in fish tank – pump in sump tank
<b>Clay</b>	Naturally occurring, consisting of fine-grained minerals which hardens when fired or dried
<b>Cycled</b>	When a system has established populations of beneficial bacteria
<b>Cycling</b>	The process of establishing bacteria populations in a system
<b>DWC</b>	Deep water culture: hydroponic method of growing plants suspended in nutrient rich water
<b>Deficiency</b>	A lack or shortage of
<b>Expanded Clay</b>	Clay pellets fired in a kiln which expands into porous “balls”
<b>Flood and drain</b>	Flooding and draining fish water in a media filled grow bed
<b>Gravel</b>	Rock particles
<b>Growbed</b>	Where the plants grow in an aquaponic system
<b>Growing media</b>	Substrate for bacteria habitat and plant root anchoring
<b>Hydroponics</b>	Growing of plants without soil
<b>NFT</b>	Nutrient film technique where plants are suspended in a small enclosed gutter and a thin film of water is passed through the roots to deliver nutrients
<b>Nitrate</b>	Naturally occurring nitrogen available for plant use
<b>Nitrite</b>	Produced as part of the nitrogen cycle, highly toxic to fish
<b>Nitrogen cycle</b>	Process which nitrogen is converted between various chemical forms
<b>Nitrobacter</b>	Bacteria which oxidises nitrite into nitrate
<b>Nitrosomonas</b>	Bacteria which oxidises ammonia into nitrite
<b>PPM</b>	Parts per million
<b>PPT</b>	Parts per thousand
<b>Purge</b>	Removal of impurities by cleansing



<b>PVC</b>	Polyvinyl chloride- plastic polymer
<b>Salt</b>	Mineral mainly composed of sodium chloride
<b>Species</b>	Biological classification for a group of organisms capable of interbreeding and producing fertile offspring
<b>Standpipe</b>	Standpipes set the maximum water level in a grow bed, and excess water that is pumped into the bed goes straight over the top of the standpipe and down the drain

# Index

## A

aquaponics . 2, 4, 6, 7, 9, 10, 11, 12, 13, 15, 16, 17, 18, 19, 20, 21, 22, 24, 27, 28, 29, 30, 31, 32, 33, 34, 36, 39, 40, 42, 45, 46, 47, 48, 52, 54, 55, 61, 72, 74, 75, 77

## D

design . 2, 3, 6, 7, 18, 22, 24, 26, 27, 28, 29, 34, 35, 38, 40, 48, 49, 53, 55, 56, 57, 58, 60, 61, 72, 73, 75, 77

## E

engineering.....6, 48, 49, 50

## M

market .... 2, 3, 6, 18, 19, 25, 29, 30, 31, 32, 34, 35, 36, 38, 39, 40, 41, 43, 48, 57, 73

## P

project.....3, 6, 7, 8, 24, 25, 26, 27, 28, 50

## S

sustainability..... 3, 5, 6, 8, 29, 38, 44, 77  
sustainable..6, 7, 24, 32, 34, 38, 39, 46, 47, 52, 73  
system . 2, 3, 4, 6, 7, 8, 9, 10, 11, 12, 13, 14, 15, 16, 17, 18, 19, 20, 21, 22, 23, 24, 25, 26, 27, 28, 29, 31, 32, 33, 34, 35, 36, 37, 38, 39, 40, 41, 42, 45, 46, 47, 48, 49, 50, 51, 52, 53, 54, 55, 56, 58, 61, 62, 69, 72, 73, 74, 75, 77, 79

## T

techniques ..... 6



